

~~SECRET~~

5AB20010573000

UNCLASSIFIED

LOS ALAMOS SCIENTIFIC LABORATORY  
of the  
UNIVERSITY OF CALIFORNIA

Report written:  
January 1954

LA-1632

This document consists of 218 pages,  
~~No. 56 of 200 copies, Series A~~

WEAPONS ACTIVITIES  
of  
LOS ALAMOS SCIENTIFIC LABORATORY  
PART I (U)  
by  
Samuel Glasstone

~~RESTRICTED DATA~~

This document contains restricted data as defined in the Atomic Energy Act of 1946. Its transmittal or the disclosure of its contents in any manner to an unauthorized person is prohibited.

DEPARTMENT OF ENERGY DECLASSIFICATION REVIEW	
1ST REVIEW-DATE: 10-7-97	DETERMINATION [CIRCLE NUMBER(S)]
AUTHORITY: SAC/ADCD/ADD	1. CLASSIFICATION RETAINED
NAME: Donald K. Davis	2. CLASSIFICATION CHANGED TO:
2ND REVIEW-DATE: 1-6-98	3. CONTAINS NO DOE CLASSIFIED INFO
AUTHORITY: ADB	4. COORDINATE WITH:
NAME: McGuire	5. CLASSIFICATION CANCELLED
	6. CLASSIFIED INFO BRACKETED
	7. OTHER (SPECIFY):

Ad Steiner AOD NO page 3  
6/1/98  
HPSchmitt 10/10/02

WEAPON DATA

~~SECRET~~

UNCLASSIFIED

965A203000235

(2)

~~SECRET~~

UNCLASSIFIED

ACKNOWLEDGEMENT

The preparation of this report has required the coverage of both considerable range and depth of technical detail. The work could not have been completed, especially in the time available, without the generous cooperation of many members of the Laboratory staff. It is impossible to mention the names of all who contributed in one way or another, but their invaluable help is gratefully acknowledged.

In the course of collecting material, I have been greatly impressed by the excellent morale and enthusiasm that prevail throughout the Laboratory. The general scientific atmosphere is undoubtedly responsible for the important progress in weapons development summarized here. In addition, it has made the preparation of this report a pleasure and a privilege.

Samuel Glasstone

UNCLASSIFIED

~~SECRET~~

UNCLASSIFIED

~~SECRET~~

Chapter 1

Principles of Nuclear Energy Production

1.1 Release of Nuclear Energy

Fission and Fusion

Any nuclear reaction in which there is a net decrease of mass, i. e., in which the total mass of the products is less than that of the interacting particles, will be accompanied by a liberation of energy. Two types of reaction have been used for the large-scale release of nuclear energy. These are (a) fission, i. e., the splitting of a heavy nucleus into a pair of lighter nuclei, and (b) fusion, i. e., the combination of two very light nuclei to form a somewhat heavier one. The underlying reason why these processes are accompanied by a decrease of mass and, hence, a liberation of energy is that in each case the average net energy of attraction between the nuclear particles, i. e., the protons and neutrons, often referred to as nucleons, is smaller in the initial nucleus (or nuclei) than it is in the products of the reaction.

Mass Defect and Binding Energy

The magnitude of the net attractive energy, or binding energy, of the nucleons in any nucleus can be calculated from the masses of the various particles. Consider an isotope of mass number  $A$  and atomic number  $Z$ , so that the nucleus contains  $Z$  protons and  $A - Z$  neutrons. If  $m_p$  is the mass of a proton,  $m_n$  is the mass of a neutron, and  $M$  is the actual mass of the nucleus, as determined by the mass spectrograph or other nuclear measurements, then the mass defect (M.D.) of the particular isotope is defined by

$$\text{M.D.} = [Zm_p + (A - Z)m_n] - M. \quad (1.1)$$

The mass defect, which may be regarded as the decrease of mass that would result if  $Z$  protons and  $A - Z$  neutrons were combined to form a given nucleus, is a measure of the binding energy of that nucleus.

Binding Energy

If the various masses are expressed in the familiar atomic mass units (amu), in which  $m_p$  is 1.00813 and  $m_n$  is 1.00897, then multiplication of M.D. by 931 gives the binding energy (B.E.) in million electron volts (Mev). This factor is based on the Einstein mass energy equation using the appropriate units of mass (amu) and energy (Mev). Consequently,

$$\text{B.E.} = 931 \left\{ [Zm_p + (A - Z)m_n] - M \right\} \text{ Mev.} \quad (1.2)$$

This gives the energy which would be released in the formation of a nucleus by the combination of the appropriate protons and neutrons or, alternatively, the energy which would be necessary to break up the nucleus into its constituent protons and neutrons.

~~SECRET~~

UNCLASSIFIED

~~SECRET~~

Fig. 1.1

A useful quantity is the mean binding energy per nucleon, i.e.,  $B.E./A$ , where the mass number,  $A$ , is the number of protons and neutrons in the nucleus. The values of  $B.E./A$  for many nuclear species have been determined, from their known masses, and when plotted against the respective mass numbers, as in Fig. 1.1, the results are found to fall on, or very close to, a continuous curve. The significant aspect of this curve, for the present purpose, is that the mean binding energy per nucleon is less for the lightest and for the heaviest nuclei than it is for those of intermediate mass.

It is this fact which accounts for the liberation of energy accompanying either the fission of heavy nuclei or the fusion of light nuclei, as can be shown in the following manner.

#### Calculation of Fission Energy

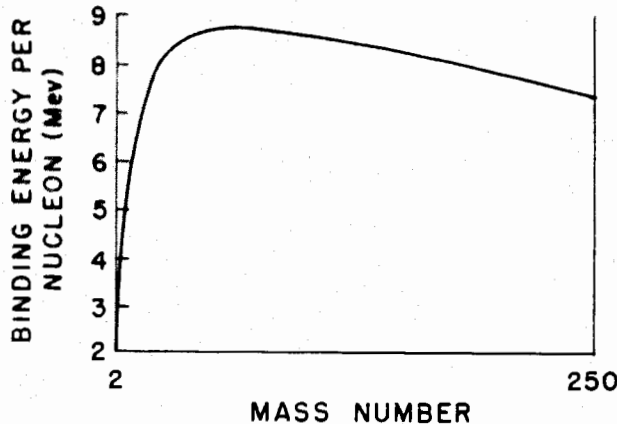
Uranium-235 undergoes fission in some thirty or more different ways, i.e., many different pairs of nuclei are formed. In the great majority of cases, however, the mass numbers of the fission products lie within the range from about 80 to 150, and from Fig. 1.1 it is seen that the average value of the binding energy per nucleon in this region is about 8.4 Mev. On the other hand, in the original uranium-235, the binding energy per nucleon is 7.5 Mev. Hence, the total energy which would be required to break up a uranium-235 nucleus into its 235 constituent nucleons would be  $235 \times 7.5$  Mev, whereas for the fission product nuclei the corresponding energy would be about  $235 \times 8.4$  Mev. In this calculation the neutrons involved in fission are neglected for simplicity, since they will have little effect on the final result. Consequently,

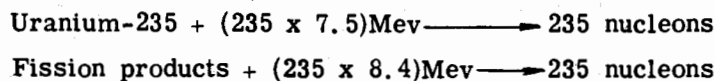

and upon subtraction and rearrangement it is seen that

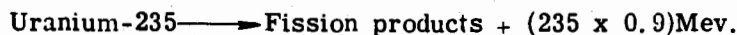

In other words, the fission of uranium-235 is accompanied by the release of  $235 \times 0.9$  Mev, i.e., about 200 Mev, of energy.

~~SECRET~~

UNCLASSIFIED

~~SECRET~~

It can be shown in an exactly analogous manner than the fusion of very light nuclei, in particular those of hydrogen and its isotopes, i. e., deuterium (D) and tritium (T), is associated with the liberation of energy, because of the difference in the mean binding energies. This is exactly the same as saying, as indicated earlier, that the mass of the products is less than that of the interacting nuclei. The difference in mass appears as energy, in accordance with the mass-energy equivalence relationship.

#### The Fission Process

Although fission of heavy nuclei can be brought about in a number of ways, there is only one that is of importance for the practical release of nuclear energy: this is fission initiated by neutrons. The reason is that the fission process is itself accompanied by the liberation of neutrons, so that a chain reaction with the continuous release of energy is possible. Only three isotopes, namely, uranium-233, uranium-235, and plutonium-239, need be considered here for use in a fission chain process. In the first place, although these substances are radioactive, they have relatively long half lives, so that they may be regarded as moderately stable. And, in the second place, they will undergo fission by the capture of neutrons of all energies, i. e., either fast (high energy) or slow (low energy).

The common isotope uranium-238 requires neutrons of at least 1 Mev energy to cause fission. Although most of the neutrons produced in fission actually have higher energies, they rapidly lose energy in collisions, so that they are brought below the threshold of 1 Mev for fission of uranium-238. Consequently, the maintenance of a chain reaction in uranium-238, is not possible. Nevertheless, fission of this isotope does occur and the energy released often makes an appreciable contribution to the total energy produced in nuclear weapons.

Of the three fissionable (or fissile) species mentioned above, only uranium-235 and plutonium-239 have hitherto been used in nuclear weapons. The amount of uranium-233 at present available is too small for this purpose, although it may become of considerable importance in the future. However, the general discussion of the fission chain process to be given here applies equally to all three isotopes. Such differences in behavior as do exist arise from a difference in the average number of neutrons produced when fission occurs and in the relative importance of fission and nonfission reactions.

The fission process may be regarded as producing three types of products: (a) lighter nuclei, called fission fragments, (b) neutrons, referred to as fission neutrons, and (c) energy. Thus, taking uranium-235 as typical, the fission act may be represented by

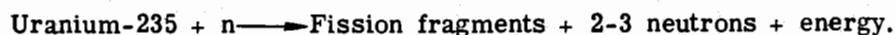

These products will be considered in turn.

~~SECRET~~

UNCLASSIFIED

UNCLASSIFIED

~~SECRET~~

The fraction of neutrons escaping from a system in which fission is taking place can be decreased by increasing the size (or mass). Since neutrons are produced, by fission, throughout the whole volume, whereas escape takes place only from the exterior surface, it is evident that the escape probability will decrease as the volume-to-area ratio of the system is increased; this is achieved, for a given geometry, by increasing the dimensions.

#### Critical Size

In a very small mass of fissile material a self-sustaining chain reaction will not be possible because of the large proportion of neutrons that escape. But as the size is increased, the fraction of fission neutrons lost will decrease and ultimately a point is reached when for every neutron captured in a fission reaction another one will become available to carry on the fission chain. The system is then said to be critical, and a self-sustaining chain reaction is just possible. If a system is smaller than the critical size (or mass) it is referred to as subcritical, and if larger, it is called supercritical. In the latter case there are more neutrons available for fission at the end of each generation than were used up to cause fission at the beginning of that generation. It will be seen below that the critical mass or size is dependent on the nature of the fissile material, its shape, and several other factors.

#### Convergent, Stationary, and Divergent Chains

If  $\nu$  is the average number of neutrons produced in each act of fission, on the average, and  $\ell$  is the average number lost, by escape and in other ways, e.g., by nonfission capture, then  $\nu - \ell$  is the number available to cause further fission; let this be represented by  $k$ , i. e.,

$$k = \nu - \ell .$$

Thus, for every neutron causing fission in one generation,  $k$  neutrons will be available to cause fission in the next generation. Hence, in accordance with the preceding paragraph,  $k$  will be less than unity in a subcritical system; in a critical system  $k = 1$ ; and in a supercritical system  $k$  will be greater than unity.

Suppose  $S$  neutrons are introduced into a fissile material and cause this number of fissions; then  $kS$  neutrons will be available for the next generation,  $k^2S$  for the next, and so on; at the end of  $n$  generations, the number of neutrons which can cause fission will be  $k^n S$ . Since, for a subcritical system,  $k < 1$ , it is evident that as  $n$ , the number of generations, increases,  $k^n S$  will approach zero. In other words, the number of neutrons will gradually decrease from one generation to the next; there is consequently a convergent or decaying fission chain which gradually dies out. For a system of critical size,  $k = 1$ , and then  $k^n S$  is always equal to  $S$ . The number of neutrons then remains constant from generation to generation. This is referred to as a stationary chain. Finally, if  $k > 1$ , as is the case for a supercritical system,  $k^n S$  increases steadily. The fission chain is then said to be a divergent or branching chain.

~~SECRET~~

UNCLASSIFIED

~~SECRET~~

UNCLASSIFIED

### Prompt and Delayed Critical

In the foregoing discussion no distinction has been made between the prompt and delayed fission neutrons. As stated earlier, however, only the prompt neutrons are significant in fission weapons, and the critical size or mass is determined by the availability of the prompt neutrons, without regard to those which are delayed. This situation is often described as prompt critical. When both prompt and delayed neutrons are required to maintain the stationary chain, as in a nuclear reactor, the term delayed critical is sometimes used. Since more than 99 per cent of fission neutrons are prompt, the neglect of the delayed neutrons has little effect on the value of  $\nu$ ; hence, the data in Table 1.1 may still be used in essentially all calculations.

### Factors Affecting Critical Mass

The critical size (or mass) is by no means a definite quantity, even for a given fissile material of specified composition. For one thing, the shape of the system has an influence on criticality, because the volume-to-area ratio varies with the geometry. The optimum condition is obtained with a sphere, for this has the largest ratio of volume to area, so that the probability of escape of neutrons is smaller than for any other shape. Thus, the critical mass of a sphere is less than that of any other geometrical form of the same material. As far as the material is concerned, it is evident that the presence of impurities will increase the critical mass of the fissile substance. Apart from the fact that the impurity may cause a loss of neutrons by parasitic capture, it adds area to the system, which increases the probability of neutron escape, without the compensating production of neutrons by fission.

It will be apparent, too, that the larger the value of  $\nu$ , the smaller will be the critical size, under the same general conditions. If more neutrons are formed per fission, it will be possible to tolerate a somewhat larger loss and yet attain criticality. Hence, the critical size of plutonium-239 is less than that of uranium-235; since the densities are not very different, this is also true for the critical masses (see Table 1.3, below).

A factor which can partially compensate for a lower  $\nu$  value is a smaller proportion of nonfission captures by the fissile material, since this will tend to increase the number of neutrons available for propagating the chain reaction. Although  $\nu$  for uranium-233 is appreciably less than for plutonium-239, the critical masses, under equivalent conditions, do not appear to differ greatly. This is because nonfission capture in uranium-233 is relatively less than in plutonium-239.

The critical size is also dependent upon the mean free path of neutrons, i. e., the average crow-flight distance a neutron will travel before interacting with a nucleus, in a given material. If the mean free path is long, the probability that a neutron will escape from the system is also large. Consequently, under comparable conditions, the critical size will be greater than for a fissile material in which the neutrons have a shorter mean free path.

~~SECRET~~

UNCLASSIFIED

# UNCLASSIFIED

~~SECRET~~

For a specified shape and composition, the size of a critical system can be decreased by surrounding it with a material which scatters neutrons back into the fissile core. By reducing the number of neutrons that escape, a smaller size (or mass) can become critical. Such a scattering material, on account of its function, is referred to, in general, as a reflector. In nuclear weapons it is called a tamper, because, in addition to decreasing the loss of neutrons by escape, it delays expansion of the exploding mass and permits a higher yield from the system undergoing fission, as will be seen later.

As is to be expected, increasing the thickness of the tamper decreases the escape of neutrons and thus makes possible a smaller critical mass of the fissile (or core) material. However, it has been shown by theoretical calculations, and verified experimentally, that when the

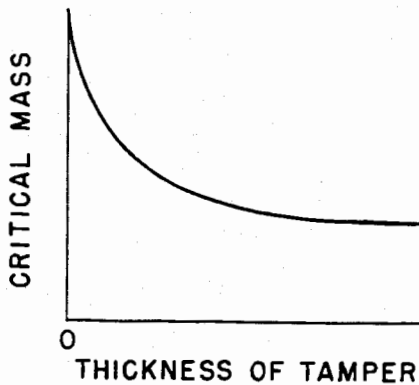

Fig. 1.2

tamper thickness reaches a certain value there is little more to be gained by a further increase of thickness (Fig. 1.2). Thus, when the thickness is about two to three neutron mean free paths in the given tamper material, its effectiveness in reducing neutron losses is within 10 per cent or so of an infinitely thick tamper.

DOE  
b(3)

Under precisely specified conditions, and for a given fissile (core) material, there is a definite mass that will be just critical. This is called a "crit." The critical masses of spheres of uranium-235 (94 per cent purity) and of plutonium-239 (97 per cent purity)

are given in Table 1.3. In the first column are the values for a bare (untamped) sphere, whereas the values in the second column are for a thick (infinite) tamper of natural uranium metal. The effect of the tamper in reducing the critical mass of the core is very striking.

Table 1.3 Critical Masses of Spheres

<u>Fissile Material</u>	<u>Bare</u>	<u>Tamped</u>
Uranium-235	52 kg	17.2 kg
Plutonium-239	16 kg	5.8 kg

It may be noted that there is still another factor which affects the critical size: it is the speed (or energy) of the neutrons causing fission. The rate of the fission process is determined by the fission cross section, as will be seen later, and this varies with the neutron energy. However, as far as nuclear fission weapons are concerned, it may be tacitly assumed that only fast

~~SECRET~~

UNCLASSIFIED



neutrons, mainly with energies in the range from 0.5 to 2 Mev, are involved. Because of the relatively long slowing-down time, fission by slow neutrons would be less effective in an explosion.

### 1.3 Attainment of Criticality

#### Assembly Method (Gun-Type Weapons)

As long as a mass of fissile material is less than the critical value, i. e., it is subcritical for the existing conditions, there is no danger of a chain reaction occurring. But, if energy is to be released, e. g., in an explosion, the system must become critical and, in fact, highly supercritical, as will be seen shortly. There are two general ways, utilized in weapons, for rapidly converting a subcritical system of fissile material into one that is supercritical.

The first may be referred to as the method of assembly. Two portions of subcritical size are brought together very rapidly, so that the combined mass is supercritical. If a burst of neutrons is then introduced, a divergent fission chain will be initiated and there will be a rapid release of energy within a very short time. This is the principle used in weapons of the gun type: one subcritical portion of fissile material is shot into another subcritical portion, the combination exceeding the critical mass.

#### Compression Method (Implosion Weapons)

The second method of attaining criticality (or supercriticality) is based on compression of the subcritical fissile material. An approximate quantitative treatment of the relationship between the compression ratio and critical mass may be derived as follows. In accordance with the definition given above, the mean free path of a neutron is the average (crow-flight) distance a neutron travels before it interacts with a nucleus. The proportion of neutrons avoiding interaction, and which can consequently escape from the system, will evidently depend on the ratio of the dimensions, e. g., the radius of a sphere, to the mean free path. It is to be expected, therefore, that for a given fissile (core) material, under specified conditions, the critical radius will be approximately proportional to the neutron mean free path; thus, if  $R_c$  is the critical radius and  $\lambda_c$  is the mean free path in the core,

$$R_c \propto \lambda_c. \quad (1.3)$$

The mean free path of a neutron is obviously inversely related to the probability of its interaction; the greater the probability of interaction, the smaller the distance the neutron will travel before it interacts with a nucleus. The probability of interaction is proportional to the number of fissile nuclei per unit volume, and hence to the density; so that, if  $\rho$  is the density of the core material,

$$\lambda_c \propto \frac{1}{\rho_c} \quad (1.4)$$

The density of the material is dependent on the compression; thus, if C is the compression ratio, i. e., the volume before compression to that after,

$$C \propto \rho_c \quad (1.5)$$

Combination of equations (1.3), (1.4), and (1.5) then leads to the result

$$R_c \propto \frac{1}{C} \quad (1.6)$$

The critical mass  $M_c$  is related to the critical radius and the density of the material by

$$M_c = \frac{4}{3} \pi R_c^3 \rho_c \quad (1.7)$$

and upon substituting equation (1.6) for  $R_c$  and equation (1.5) for  $\rho_c$ , it is seen that

$$M_c \propto \frac{1}{C^2} \quad (1.8)$$

The critical mass of a given fissile material is thus inversely proportional to the square of the compression ratio. By increasing the compression the critical mass is consequently decreased.

It follows, therefore, that if a subcritical mass of fissile material is compressed it may become supercritical. DO  
(b)

In other words, it will be highly supercritical, and the introduction of neutrons will cause a rapidly divergent fission chain to develop.

If the mass of fissile (core) material is tamped, then the result in equation (1.8) is true only if both the tamper and the core are compressed to the same extent. Actually, uniform compression is not attained throughout; it is greater near the center of the bomb, i. e., in the core, than further out, e. g., in the tamper. Even within the core itself there is a compression gradient. In general, therefore, the relationship between the critical mass and the average compression ratios of the core ( $C_c$ ) and of the tamper ( $C_t$ ) may be represented by

$$M_c \propto \frac{1}{C_c^{1.2}} \cdot \frac{1}{C_t^{0.8}} \quad (1.9)$$

so that when  $C_c$  and  $C_t$  are identical, this reduces to equation (1.8). For most cases of interest in the weapons field, a good approximation is

$$M_c \propto \frac{1}{C_c^{1.7}}, \quad (1.10)$$

since the conditions are such that the tamper is compressed to a smaller extent than is the core.

The use of compression to attain supercriticality is employed in weapons of the implosion type; the reason for this name will be seen later. Not only does increased compression result in a decrease in critical mass, it is also accompanied by an increase in efficiency of the energy release, as will be seen in Section 2.1. Consequently, the attainment of higher and higher compressions is one of the important objectives of weapon development.

#### 1.4 Neutron Multiplication

##### Rate of Fission Reaction

No matter how it originates, an explosion involves the very rapid liberation of a large amount of energy. If the energy is to be produced by fission, then the necessary condition is a very high neutron density, since the rate of fission, and, hence, the rate of energy release, is proportional to the number of neutrons per unit volume. It is of interest, therefore, to investigate the circumstances which lead to a high neutron density.

It was seen earlier that the number of neutrons available to cause fission, for every neutron captured in a fission process, in each generation is equal to  $k$ , i. e., to  $\nu - \ell$ , where  $\nu$  is the average number of neutrons produced per fission and  $\ell$  is the average number lost by escape and nonfission capture. This means that for every  $n$  neutrons present at the beginning of a generation, there will be  $nk$  present at the end, so that the gain of neutrons is  $n(k - 1)$  per generation. The rate of gain,  $dn/dt$ , may then be obtained, roughly, upon dividing the actual gain by the average time,  $\tau$ , between successive fission generations; hence,

$$\frac{dn}{dt} = \frac{n(k - 1)}{\tau}. \quad (1.11)$$

This result will be strictly correct only if the delayed neutrons play no significant part in maintaining the fission chain. As seen above, this condition is applicable to nuclear fission weapons.

The quantity  $k - 1$ , which is the excess number of available neutrons per fission, may be

The fission mean free path is equal to  $1/N\sigma_f$ , where  $N$  is the number of fissile nuclei per  $\text{cm}^3$  and  $\sigma_f$  is the fission cross section.\* Hence, from equation (1.18),

$$\tau \approx \frac{1}{N\sigma_f v}, \tag{1.19}$$

so that the generation time is inversely related to the product  $\sigma_f v$ .

\*For the present purpose, the cross section may be regarded as the effective area of a nucleus for a particular reaction (or reactions). It is usually expressed in barns, i. e.,  $10^{-24} \text{ cm}^2$  units.

SECRET

Explosion Time

It will be noted, incidentally, that  $1/\alpha$ , the e-folding time, is of the same order as  $\tau$ , the generation time. Consequently,  $1/\alpha$  is frequently identified with the generation time, and  $\alpha t$  is then the number of generations which have elapsed during the time interval  $t$ . It is thus possible to write equation (1.16) in the approximate form

$$n \approx n_0 e^g, \tag{1.21}$$

where  $g$  is the number of generations in which the neutron density increases from  $n_0$  to  $n$ . In other words, the neutron population increases roughly by a factor of  $e$  per generation, i. e., by a factor of 10 in every 2.3 generations.

Before a fissioning system can explode, i. e., before the material commences to move outward, a certain energy density must be attained. ]

DCE  
66

SECRET

~~SECRET~~

The fission chain reaction then gradually dies out, because the increasing rate of neutron escape causes  $\alpha$  to decrease and eventually to become negative. [

Obviously, to obtain a high efficiency, the expansion of the core must be delayed as much as possible, and this is an important function which must be fulfilled by the tamper. DO

#### Spontaneous Fission

The fission processes discussed so far have been those involving the deliberate introduction of neutrons. These reactions can also be brought about by extraneous neutrons, such as those present in cosmic rays or resulting from the action of alpha particles, emitted by uranium or plutonium, on certain impurities. In addition, there is the possibility of completely spontaneous fission of certain nuclei, without the intervention of neutrons. It is important to point out, however, that such spontaneous fissions are, nevertheless, accompanied by neutron emission and the latter are capable of causing further fissions.

The spontaneous fission rates, expressed as the number of nuclei undergoing fission per hour per gram of material, of some isotopes of uranium and plutonium are given in Table 1.4. Since two to three neutrons are liberated per fission, the rate of neutron emission is obtained upon multiplication of the fission rates by the appropriate number. The spontaneous fission rates of uranium-233, uranium-235, uranium-238, and plutonium-239 are fairly small, but those

Table 1.4 Spontaneous Fission Rates

<u>Isotope</u>	<u>Fission/hour/gram</u>
Uranium-233	< 0.7
Uranium-234	<30
Uranium-235	1.3
Uranium-238	24
Plutonium-238	$1.1 \times 10^7$
Plutonium-239	35
Plutonium-240	$1.6 \times 10^6$

of plutonium-238 and -240 are considerable. The former of these two isotopes is of no significance in the production of weapons, but some plutonium-240 is almost invariably present in plutonium-239 and its high spontaneous fission rate is of serious consequence in connection with fission weapons.

~~SECRET~~

~~SECRET~~1.5 Production of Weapon MaterialsUranium-235

The two important fissile materials, namely, uranium-235 and plutonium-239, are both produced from natural uranium but by entirely different procedures. Ordinary uranium contains about 0.7 per cent of uranium-235 to 99.3 per cent of uranium-238, and a trace (0.006 per cent) of uranium-234. The uranium-235 is separated by diffusion (through porous barriers) of the vapor of uranium hexafluoride ( $UF_6$ ), made from natural uranium. The hexafluoride of the lighter isotope diffuses more rapidly than does that of the heavier species, and by the use of several thousand diffusion stages an enrichment of 93.5 per cent, i. e., a material containing an isotopic proportion of 93.5 per cent of uranium-235, can be obtained. The highly enriched uranium hexafluoride is then converted into the tetrafluoride ( $UF_4$ ) by heating with hydrogen or methane. The uranium tetrafluoride is reduced to metal by means of calcium plus some iodine to act as a "thermal booster." Reaction between iodine and part of the calcium starts at about  $400^{\circ}C$ ; the heat generated raises the temperature sufficiently for rapid reduction of the tetrafluoride by calcium to take place.

Plutonium-239

The element plutonium occurs in nature as virtually insignificant traces, at best. Consequently, the plutonium-239 used in weapons is obtained artificially by a series of nuclear reactions resulting from the exposure of uranium-238 to slow neutrons in a nuclear reactor or "pile." A nuclear reactor is a device in which a fission chain reaction is taking place in a controlled manner. If a material of low mass number, called a moderator, is present, in addition to fissile material, the fission neutrons will be slowed down, and such a system is, in a sense, a source of slow neutrons.

In a reactor, uranium-238 captures neutrons to form a higher isotope, uranium-239, with the emission of gamma radiation; thus

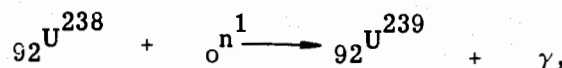

where the subscripts give the atomic numbers, i. e., number of protons, and the superscripts indicate the mass numbers, i. e., total number of neutrons and protons in each case. The uranium-239 is radioactive, with a half life of 23 min, emitting a beta particle. Representing the latter by  ${}_{-1}\beta^0$ , since it carries a negative charge and has essentially no mass, the radioactive decay process may be written as

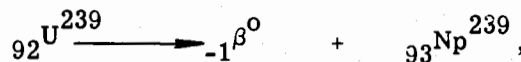
~~SECRET~~

~~SECRET~~

the product being an isotope of a new element, atomic number 93, called neptunium (Np), of mass number 239. Neptunium-239 is also radioactive, half life 2.3 days; it emits a beta particle according to the reaction

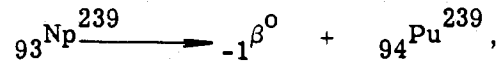

so that the product, atomic number 94, mass number 239, is plutonium-239. This is an alpha emitter with a fairly long half life--about 24,000 years--and hence it is relatively stable.

It may be mentioned that the decay product of plutonium-239 is the fissile uranium-235, its half life being about  $9 \times 10^8$  years. Hence, as far as fission is concerned, plutonium will undergo only relatively minor changes over a period of several hundred years. The same is true, of course, to an even greater extent, for uranium-235.

As the plutonium-239 accumulates in a reactor, it also begins to capture neutrons, the rate of capture being proportional to the neutron density and to the concentration of plutonium-239 nuclei. The process is

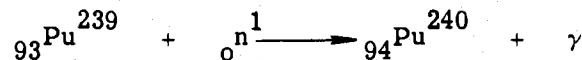

with plutonium-240, an alpha emitter of half life about 6500 years, as the product. The two isotopes of plutonium cannot be separated from each other in the chemical process used for the extraction of plutonium from the fission products and the unchanged uranium discharged from a production reactor. Hence, plutonium-239 is always associated with a certain proportion of plutonium-240, the amount increasing, up to a limiting value, with the exposure time of the material in the reactor, and also with the neutron density.

The amount of plutonium-240 present in the uranium fuel elements, as they are called, increases, up to a limiting value of about 35 per cent, with the time spent in the reactor and with the reactor power. Consequently, the quality of plutonium, as regards its plutonium-240 content, is frequently described in terms of megawatt-days of exposure in the reactor per ton of uranium fuel, i. e., in MWD/T units. Actually, the unit is not too precise because the reactor power is not uniform throughout its volume, so that the plutonium-240 content corresponding to a given average MWD/T value depends on the location of the fuel element in the reactor. However, because many fuel elements ("slugs") are processed simultaneously, the results average out sufficiently well for practical purposes.

~~SECRET~~DEF  
b(3)



DOE (2)

DOE d

At the present time essentially all the plutonium in the United States is made at Hanford, Wash., in reactors employing natural uranium, in the metallic form, with graphite as the moderator for slowing down the neutrons. The uranium-235 present maintains the fission chain, while the uranium-238 captures some of the neutrons. This leads, ultimately, to the formation of plutonium-239, as seen above. In the new production plant being built at Savannah River, S. C., natural uranium will be the fuel, as at Hanford, but the moderator will be heavy water, i. e., water highly enriched in the heavier isotope, deuterium.

#### Code Names

There are a number of code names and symbols frequently employed in connection with nuclear weapons work. Uranium metal enriched in the uranium-235 isotope, originating in Oak Ridge, is often called oralloy, an abbreviation of "Oak Ridge alloy." It is represented by the symbol Oy, followed by a number in parentheses indicating the percentage enrichment; thus Oy(93.5) indicates a material containing 93.5 per cent of uranium-235 and 6.5 per cent of uranium-238 and other isotopes. Until recently, this was the only form of enriched material in general use and it is this composition which is frequently referred to as oralloy or Oy, without qualification. However, some applications of a less enriched product, Oy(37.5), are now being made.

The corresponding code name tuballoy, symbol Tu, is used for uranium metal, in the normal isotopic proportions, i. e., 99.3 per cent uranium-238. It is based on the designation Tube Alloys Limited applied to the British wartime atomic energy project. The metal obtained from the depleted uranium residues of the gaseous diffusion plants, containing more than 99.3 per cent of uranium-238, is sometimes called "Q" metal.

The names mentioned above are generally used for specific materials. A (declassified) code system of another kind is frequently employed to represent particular isotopes. The last numerals of the atomic number and of the mass number are combined to give a two-digit symbol that is characteristic of the particular species. Thus, uranium-235, mass number 92, is referred to as "25"; uranium-238 is "28"; and plutonium-239, atomic number 94, is "49".

\*Up to 1000 MWD/T, at least, the percentage of plutonium-240 is roughly proportional to the exposure.

~~SECRET~~Production of Neutrons

In an atomic weapon, the chain reaction is initiated by the introduction of neutrons into the highly supercritical system. Consequently, the methods for producing neutrons may be briefly reviewed. Two main procedures will be considered here, others will be mentioned in Section 1.6.

One of the simplest methods for obtaining neutrons is by the action of alpha particles of sufficient energy on certain light elements, notably beryllium. The reaction may be represented by

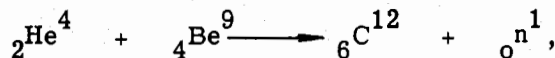

recalling that the alpha particle is identical with a helium nucleus. For laboratory purposes, radium is a very convenient source of alpha particles, but for several reasons it is not practical for use in nuclear weapons. The alpha-particle source employed is the radioelement polonium-210. This has the advantage of being relatively simple to make and, unlike radium, neither plutonium itself nor its radioactive decay products emit gamma radiation. Polonium-210 is produced by exposure of bismuth to neutrons in a nuclear reactor, when the reaction

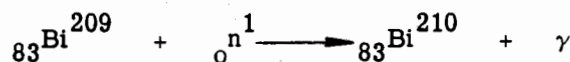

occurs. The bismuth-210 is a beta-emitter, with a half life of 5 days, and so it soon decays to form polonium-210; thus,

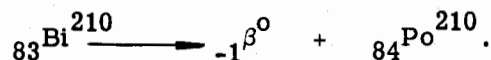

The use of polonium-210 has, however, three drawbacks. Its half life is only 138.4 days, so that the neutron source has a short stockpile life and requires frequent replacement. In addition, the polonium constitutes a health hazard and special precautions must be taken in fabrication. Finally, its production requires neutrons which could otherwise be used for making plutonium. There is consequently considerable interest in the development of neutron sources which do not involve polonium.

DOE  
6(3)~~SECRET~~

1.6 Thermonuclear ReactionsLimitations of Energy Release

It should be apparent from the earlier discussion that the energy release of a nuclear fission weapon is limited by the mass of fissile material which can be included in it and yet retain a subcritical system. It should be remembered, of course, that the critical mass depends on the geometry of the system. Consequently, if desired, a large mass of fissile material can be made subcritical by fabrication into a form in which it has a large exposed area, e.g., a spherical shell.

DOF  
b(2)Fusion Reactions

Nuclear reactions of the fusion type were first attained in the laboratory by using charged particles, e.g., protons (hydrogen nuclei), deuterons (deuterium nuclei), or tritons (tritium nuclei), which were accelerated in a cyclotron, Van de Graaff generator, or similar device. In this manner, the nuclear particles acquire sufficient energy to permit them to react with other light nuclei. Since this energy is merely kinetic energy, it is not different from that which a nucleus would acquire as a result of raising its temperature. Thus, assuming a Maxwell-Boltzmann distribution of energy among the nuclei, it is found that the mean kinetic energy corresponding to a temperature of  $T^{\circ}$  Kelvin is  $8.6 \times 10^{-11}T$  Mev. Consequently, it is to be expected, and has been confirmed by experiment, that nuclear reactions can be brought about by the use of high temperatures. Such processes are referred to as thermonuclear reactions.

The thermonuclear reactions which have been achieved so far involve only the heavier isotopes of hydrogen, i.e., deuterium and tritium.\* This is because the necessary kinetic energies are lower, and, hence, so also are the requisite temperatures, than for other nuclear processes.

As a first approximation, the minimum interaction energy may be regarded as that required to overcome the electrostatic repulsion forces operating between the interacting nuclei. If  $Z$  and  $Z'$  are the respective positive charges, i.e., atomic numbers, and  $r$  is the distance

\*The descriptions given here refer only to thermonuclear processes achieved by man; these and other such reactions take place in various heavenly bodies and constitute their energy sources.

between the nuclei, the coulombic repulsion energy is  $ZZ'e^2/r$ , where  $e$  is the value of the electronic charge. This energy will be least for reactions between hydrogen nuclei, since  $Z$  and  $Z'$  are then both unity; the repulsion energy which must be overcome is consequently  $e^2/r$ .

If electrostatic repulsion were the determining factor, the energy required for the above reactions would be roughly 0.1 Mev; this would correspond to the extremely high temperature of about  $10^9$  °K. However, for various reasons, which are explicable in terms of quantum mechanics, it has been found that the reactions involving deuterium and tritium will take place at an appreciable rate at energies of the order of 1 to 10 kev, i. e.,  $10^{-3}$  to  $10^{-2}$  Mev.

DOE  
b(3)

Three thermonuclear reactions are of particular importance. These are represented below, together with the amount of energy released as calculated from the masses of the nuclei involved:

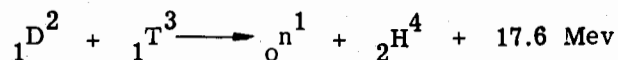
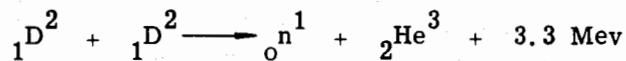
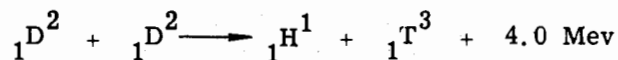

The D-D and D-T reactions have possible applications in two different directions to be described shortly.

#### Thermonuclear Energy Release

Since the energy liberated in these reactions is several Mev in each case, whereas they can be initiated, at least, by energies of from 1 to 10 kev, it is apparent that a kind of thermonuclear chain is possible. Thus, if the energy liberated in the reaction between a quantity (or volume) of deuterium nuclei can be used to raise the temperature of other such nuclei, then further D-D reactions will result, and a self-sustaining thermonuclear propagation will be possible. As in the case of the fission chain, this will be accompanied by the continuous release of energy. Whereas in the fission reaction the chain is maintained by neutrons, the thermonuclear propagation is maintained by thermal energy.

\*It has become the practice in thermonuclear work to express the temperature in terms of the equivalent kinetic energy. Thus, reactions involving deuterium and tritium are said to take place at "temperatures of 1 to 10 kev."

~~SECRET~~

UNCLASSIFIED

It may be remarked that in many respects thermonuclear propagation (or burning) is analogous to the process which takes place in an internal combustion engine. The spark initiates the reaction between a quantity of oxygen and gasoline; the energy generated then raises the temperature of adjacent material to such an extent that reaction can occur, and so on.

#### Thermonuclear Neutron Production

It will be observed that one of the D-D reactions and the D-T reaction, referred to above, yield neutrons as a product. In the latter case, the energy of the neutrons is about 14 Mev, as may be readily calculated on the basis of conservation of momentum between the neutron and the helium nucleus formed in the process. Neutrons produced by these thermonuclear processes have been used to initiate the fission chain or to introduce a burst of neutrons at a later stage in order to maintain and enhance the progress of the fission reaction.

It should be noted that the D-D reaction which leads to the formation of H and T will be followed by interaction between the tritium and any unchanged deuterium nuclei that may still be present. This D-T reaction will, of course, result in the production of additional neutrons.

#### Thermonuclear Weapons

One of the reasons for the interest in thermonuclear weapons has been indicated earlier. The energy release of a fission weapon is limited by safety considerations which make it necessary to maintain the fissile material, before detonation, in a subcritical state. Deuterium and tritium, on the other hand, can be safely held in large volumes, and the amounts that could be included in a weapon would be determined only by practical considerations. Consequently, the energy yield of a weapon utilizing the deuterium and tritium reactions would be limited only by the quantity of material that could be used. Thus, weapons of extremely high yields are feasible at a considerably lower cost than is possible for equivalent fission weapons.

Tritium is made in nuclear reactors and its production involves the capture of a neutron by a lithium nucleus, as will be explained shortly. The same neutron could be used to produce plutonium, and so each tritium atom formed represents the loss of an atom of plutonium. In a reactor using natural uranium as fuel there will inevitably be some plutonium production, and so, even if it were desirable, the available neutrons could not be used exclusively for tritium production. Consequently, this isotope will be expensive and not too common. There is a possibility that lithium could be used, in place of cadmium, as a central absorber to make the neutron flux (and heat liberation) in a nuclear reactor more uniform. In this event, tritium would be produced by means of neutrons which are otherwise wasted.

A further matter of significance may be mentioned: tritium is radioactive, and its half life is only about 12.5 years. Hence, in addition to being somewhat of a health hazard, it decreases in amount at an appreciable rate. The beta-decay product is helium-3, and this can react with

~~SECRET~~

UNCLASSIFIED

deuterium to yield a fairly large amount of energy, i. e. ,

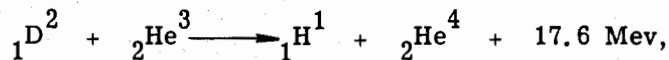

but the higher charge of the helium nucleus makes this reaction less probable than the D-T reaction. However, when neutrons are available, e. g. , from a D-D or D-T reaction, the tritium may be regenerated by the reaction

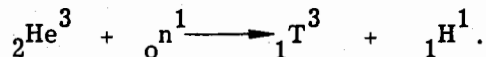

In a nuclear reactor, one neutron can be made to yield one plutonium atom or one tritium atom. But whereas fission of a plutonium atom liberates about 200 Mev, a thermonuclear reaction with tritium releases only 18 Mev. It would thus seem, at first sight, that use of tritium in a weapon would be a highly uneconomic procedure. The justification lies, however, in the fact that a relatively small amount of tritium may be made, in various ways, to help initiate a D-D reaction in a large quantity of the much less expensive and more readily available deuterium.

#### Production of Deuterium and Tritium

Deuterium oxide (heavy water) is present to the extent of about 1 part in 6500, i. e. , 0.015 per cent, in ordinary water. In spite of this very small proportion, enrichment of water in deuterium is not too difficult, and heavy water of 99 per cent purity is now produced on the industrial scale. Large quantities are required to supply the need for a moderator in the Savannah River, S. C. , plant for plutonium and tritium production.

Three main processes have been used to achieve a partial separation of the hydrogen isotopes in water: these are (a) isotopic (chemical) exchange, (b) distillation, and (c) electrolysis. In the isotopic exchange process, hydrogen gas or a gaseous compound of hydrogen is made to react with liquid water. As a result of the somewhat different reactivities of the two isotopes, there is a partial separation between the liquid and gaseous phases. The large-scale production process now operated by AEC contractors, utilizes the reaction between hydrogen sulfide gas and water. The exchange reaction results in a relatively higher proportion of deuterium in the liquid phase than in the gas. By utilizing a countercurrent flow of gas and liquid in several stages, considerable enrichment in deuterium can be achieved in the liquid.

The distillation method for separating the isotopes of hydrogen depends on the fact that heavy water has a slightly higher boiling point, i. e. , lower vapor pressure, than light water. Consequently, a partial separation can be achieved by fractional distillation, preferably under reduced pressure.

UNCLASSIFIED

~~SECRET~~

When a slightly acid or alkaline solution in water is electrolyzed, the hydrogen gas liberated at the cathode contains relatively more of the lighter isotope than does the water. By repeated electrolysis in stages, heavy water of a high degree of enrichment can be obtained.

Each of the three foregoing procedures has certain advantages under suitable conditions. Hence, for the production of heavy water in quantity, ordinary water is first partially enriched by the isotopic exchange process. The deuterium is further concentrated by fractional distillation under vacuum, and then it is finally brought up to about 99 per cent enrichment by electrolysis. Deuterium itself can be released from heavy water by any of the familiar chemical methods used to prepare hydrogen gas. It can then be converted into any compound that may be required, or it may be liquefied by cooling under pressure, in the usual manner, to obtain liquid deuterium.

Tritium is produced by exposure of lithium to slow neutrons in a nuclear reactor; the less abundant lithium-6 isotope then undergoes the reaction

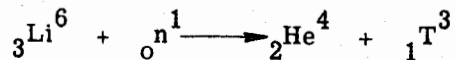

with the formation of tritium. This isotope can be converted into compounds or liquefied, just like other forms of hydrogen. It is expected that larger quantities of tritium will become available when the reactors at the Savannah River plant commence operation.

UNCLASSIFIED

~~SECRET~~

~~SECRET~~

UNCLASSIFIED

Chapter 2

Efficiency of Fission Weapons

2.1 Determination of Efficiency

Definition of Efficiency

The efficiency ( $\phi$ ) of any weapon may be defined as the ratio of the energy actually developed when it explodes, i. e., the energy yield, to the total energy available, i. e.,

$$\phi = \frac{\text{energy yield}}{\text{energy available}} \quad (2.1)$$

In other words, it is the fraction of the energy available which is actually released in the explosion. In the case of a fission weapon this is equal to the ratio of the number of nuclei which actually undergo fission to the total number of fissile nuclei present.

In designing a fission weapon it is essential to be able to estimate its yield from theoretical considerations. But the calculation of the efficiency is very complicated, involving a detailed hydrodynamic treatment of the core material and tamper during the main period of energy release, i. e., in the interval between about the 50th and 55th generations after initiation of the fission chain. With the availability of high-speed electronic computers, such as the IBM 701 and the MANIAC, progress is now being made in the rapid calculation of the efficiency of any proposed fission weapon. However, the procedures are tedious and not necessarily complete, so that other, partially empirical, methods for determining efficiencies are still in general use.

Detailed Calculation Procedure

The following description is intended as a brief outline of the detailed method for calculating weapon yields (or efficiencies); its purpose is merely to give a general indication of the procedure used. The bomb assembly is divided, somewhat arbitrarily, into a finite number of concentric shells, and the time behavior of each shell, or "mass point," is determined by numerical calculations using equations describing the processes of neutron production, material acceleration, and heat flow. The initial time for purposes of these calculations, at which significant physical effects may be assumed to begin, is taken as that after the 50th generation. Up to this time the mass points are essentially stationary, and very little energy has been liberated. The subsequent changes with time, as the system expands, are treated by calculating the neutron density, position, and physical properties of the mass points at time  $t + \Delta t$  in terms of those existing at time  $t$ . For convenience, different time intervals  $\Delta t$  may be taken for different purposes.

Starting with the initial radii, masses, and nature of the fissile material for the several mass points, the values of  $\alpha$  and of the neutron distribution at the zero time can be determined

UNCLASSIFIED

~~SECRET~~



by some form of neutron transport theory. Then, making use of this alpha and the familiar equation (1.16), for the time rate of increase of neutron population, the neutron distribution after the interval  $\Delta t$  can be evaluated.

The next step is to determine the acceleration of the mass points by hydrodynamic calculations; this gives the velocity at  $\Delta t$ , from which the new radii of the mass points can be obtained. Finally, the temperature distribution is calculated from the heat flow equation, taking into account the energy produced by fission, the work done by the mass points in their outward motion, and the transfer of energy by radiation.

These calculations complete one cycle, since the new neutron densities, radii, and temperatures of the mass points are now known. From the temperatures, the new physical properties are determined. The whole procedure, starting with alpha and the neutron distribution, is repeated over and over until the bomb has completely exploded and the rate of energy release by fission has fallen almost to zero. Upon summing the number of fissions which have taken place, the total energy yield can be obtained. This includes the energy released by fission after the system has expanded and become subcritical. Although chain propagation is no longer possible, interaction of the many neutrons and fissile nuclei still present will result in a considerable energy production; this may amount to some 30 per cent of the total yield.

#### The Bethe-Feynman Formula

The formula for the efficiency of a nuclear explosion derived by Bethe and Feynman is admittedly approximate since it involves a number of simplifying assumptions. It is based largely on the following arguments. As a result of the energy liberated in fission, very large pressures are developed in the core, and the core-tamper interface consequently receives a large outward acceleration. This causes highly compressed tamper material to pile up just ahead of the expanding interface, in an effect referred to as the "snowplow" phenomenon, because of its similarity to the piling up of snow in front of a snowplow. The inertia of the compressed tamper will delay expansion of the core, so that a considerable pressure gradient will build up from the center of the core to its outer surface.

Further, as a result of the delayed expansion, it may be supposed that the volume of compressed core remains essentially constant during the first 50 or so generations following initiation of the fission chain. After this interval, almost the whole of the bomb energy is released within an extremely short period, during which time the core expands rapidly until it becomes subcritical. Although there is an appreciable energy release in this state, as seen above, the liberation of energy may be regarded as over when the dimensions are just critical. It will be assumed, in the subsequent treatment, that during the very short period while the energy is being released, none escapes from the system. It may be remarked that most of the

*Do not delete*

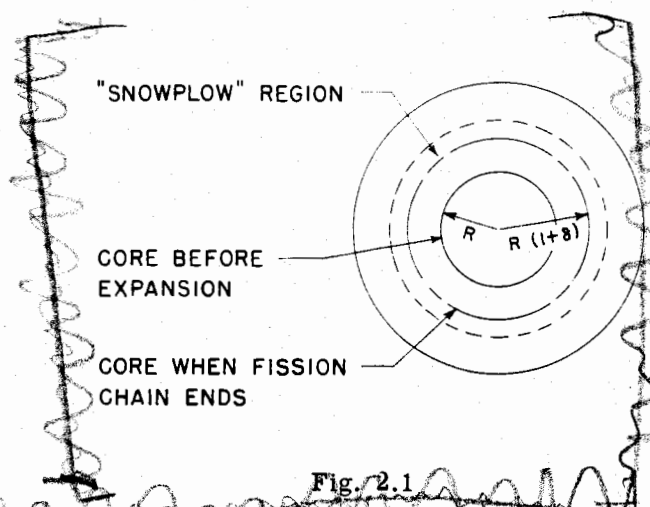

approximations and assumptions involved are applicable when the efficiency is small, and it is for this condition that the Bethe-Feynman treatment is justifiable.

Let  $R$  be the radius of the core at the point of maximum supercriticality; then, in accordance with the postulate made above, this will remain unchanged until about the 50th generation after initiation of the fission chain. Subsequently, the energy content of the system becomes so large that mechanical effects begin and the core starts to expand.

Suppose that when the core has expanded by a fraction  $\delta$ , so that the radius is  $R(1 + \delta)$ , the system is just critical (Fig. 2.1). Beyond this point the core material will be subcritical; the fission chain will end and there will be, according to an earlier assumption, essentially no further release of energy.

Consider a thin shell of material in the core, of volume  $dV$  and thickness  $dr$ ; the cross-sectional area of the shell is then  $dV/dr$ . If  $dP$  is the pressure difference on the two sides of this shell, caused by the fission energy liberated, the net outward force,  $F$ , to which the shell is subjected, i.e., pressure  $\times$  area, is then

$$F = dP \frac{dV}{dr} = \frac{dP}{dr} dV, \tag{2.2}$$

where  $dP/dr$  is the pressure gradient in the given shell. As a reasonable approximation, it may be supposed that the pressure gradient is constant throughout the core, so that it is possible to write

$$\frac{dP}{dr} \approx \frac{P}{R}, \tag{2.3}$$

where  $P$  is the total difference in pressure from the center of the core to the outer surface. Hence, from equations (2.2) and (2.3),

$$F \approx \frac{P}{R} dV. \tag{2.4}$$

The time required for the core to expand from radius  $R$  to  $R(1 + \delta)$  a distance of  $R\delta$ , is about five generations. However, as a rough approximation this may be taken as  $1/\alpha$ , where  $\alpha$  is the multiplication rate when fission is initiated, as described in section 1.4.

Hence, the mean outward acceleration of the core material, and of the shell  $dV$ , may be expressed as  $R\delta\alpha^2$ . The mass of the shell is  $\rho_c dV$ , where  $\rho_c$  is the core density, and, hence, by Newton's second law of motion, i.e., force = mass x acceleration, the force acting on the shell is given by

$$F \approx R\delta\alpha^2 \times \rho_c dV .$$

Upon comparing this result with equation (2.4), it is seen that

$$P \approx \rho_c R^2 \alpha^2 \delta . \quad (2.5)$$

At the existing temperatures the core material will be in the gaseous state, and if, as postulated, the loss of energy from the system during the initial expansion is negligible, it may be considered as a gas undergoing an adiabatic process. The total energy of such a gas, which may be regarded as equal to the energy of the core, is then

$$E = \frac{PV}{\gamma - 1} , \quad (2.6)$$

where  $\gamma$  is the ratio of the specific heats of the gas. Using equation (2.5) for  $P$  and writing  $M/\rho_c$  for the volume of the core,  $M$  being the mass, equation (2.6) becomes

$$E \approx \frac{MR^2 \alpha^2 \delta}{\gamma - 1} . \quad (2.7)$$

If  $\epsilon$  is the energy released in the complete fission of unit mass of core material, i.e., about 0.017 kt per gram for uranium-235 and 0.019 kt per gram for plutonium-239, then the total energy available in the core is  $M\epsilon$ , and the efficiency, by equation (2.1), should be  $E/M\epsilon$ , where  $E$  is given by equation (2.7). However, this is not strictly correct, for in the derivation of this equation no allowance has been made for the depletion of the core material as fission proceeds. For low efficiencies this is, of course, not important, but a distinction will, nevertheless, be made by writing  $\phi'$  for the value obtained using equation (2.7), so that

$$\phi' = \frac{E}{M\epsilon} \approx \frac{R^2 \alpha^2 \delta}{(\gamma - 1)\epsilon} , \quad (2.8)$$

where  $\phi'$  may be related to the true efficiency,  $\phi$ , by a relationship such as

$$\phi = \frac{\phi'}{1 + 1.2 \phi'} , \quad (2.9)$$

sometimes referred to as the depletion correction.

If the tamper density,  $\rho_t$ , is not very different from that of the core, then, within a

~~SECRET~~

UNCLASSIFIED

moderate range of efficiencies, approximate allowance for the effect of the tamper may be made by a factor proportional to  $(\rho_t/\rho_c)^n$ , where n is less than unity. The limited applicability of the correction may be seen from the fact that it fails completely when there is no tamper, i.e., when  $\rho_t$  is zero. However, upon introducing this correction factor, with  $n = 0.5$ , into equation (2.8), the result is

$$\phi' \propto \frac{1}{(\gamma - 1)\epsilon} R^2 \alpha^2 \delta \sqrt{\frac{\rho_t}{\rho_c}} \quad (2.10)$$

The first factor on the right side is a constant, k, so that equation (2.10) reduces to

$$\phi' \approx kR^2 \alpha^2 \delta \sqrt{\frac{\rho_t}{\rho_c}} \quad (2.11)$$

which is one form of the Bethe-Feynman formula.

DE  
h(3)

Since the total mass of fissile material is known, the actual energy release can also be evaluated.

By comparison with experimental determinations, to be described in Chapter 6, it has been found that while the Bethe-Feynman formula is a useful qualitative guide, it is not always quantitatively correct. For example, the so-called constant, k, varies with the yield and with the composition of the core material, e.g., either plutonium alone, or alloy alone, or combinations of both in various proportions. Hence, normalization procedures must be adopted when using equation (2.11). As an increasing amount of information has become available, it has been found possible to adjust the value of k, and also to make other semi-empirical corrections. Carefully applied, the Bethe-Feynman approximation has been used successfully to design bombs having a wide range of energies. For complex assemblies or where fine distinctions are sought, however, more exact methods of calculating efficiencies are used, e.g., the detailed procedure described earlier or the crits method given below.

Effect of Size and Compression on Efficiency

From an examination of equation (2.11) a number of general conclusions can be drawn concerning the factors affecting the efficiency of a nuclear explosion. In the first place, since the efficiency increases as  $R^2$ , it would be advantageous for the core to be large at the time of initiation of the fission chain. This can be achieved in practice by bringing together sub-critical masses which are designed to contain a large total amount of fissile material. Thus, for a given compression (or for no compression), the efficiency would be expected to be

UNCLASSIFIED

~~SECRET~~

greater the larger the mass of the core material. This expectation has been confirmed in numerous tests.

Although compression will result in a decrease in R, this will be more than compensated for by the considerable increase in  $\alpha^2$ , for the reasons given in Section 1.4. In addition, the effect of compression on  $\delta$  must be taken into account; the more highly compressed the core material at the time of initiation, the further will be the distance the surface will travel before the supercritical system becomes just critical. Thus, increased compression should result in a marked increase of efficiency; that this is the case is shown very simply by comparing the yield from a gun-type weapon, in which there is no compression, with that of an implosion weapon.

DOE b(1)

The effect of increasing the compression in an implosion weapon is indicated by the data in Table 2.1 which are based partly on experiment and partly on calculation.

DOE b(1)

Table 2.1 Effect of Compression on Efficiency

Average Compression		Efficiency (per cent)
Core	Tamper	

DOE b(1)

Calculation of Efficiency by the Crits Method

DOE b(1)

Consider a system containing a mass M of fissile material under a compression  $C_c$ ; let  $M_c$  be the critical mass of the material under these conditions with a specified tamper. Then the number of crits or critical masses, N, present is given by

$$N = \frac{M}{M_c} \tag{2.12}$$

According to equation (1.8), however,  $M_c$  is proportional to  $1/C_c^2$ , and so if  $M_{c0}$  is the critical mass of the uncompressed material, i.e., when  $C_c = 1$ , with the same tamper, in the assembled

~~SECRET~~

form, it follows from equation (2.12) that

$$N = \frac{MC_c^2}{M_{co}}$$

UNCLASSIFIED

(2.13)

From the general discussion of the Bethe-Feynman formula it was seen that increasing either the mass of fissile material or of the core compression results in an increase of efficiency. It is evident, therefore, from equation (2.13) that the efficiency of a weapon will increase with the number of crits present at the explosion time. This qualitative result is of considerable interest, but a more quantitative development is possible, e.g., by expressing  $\alpha$  and  $\delta$  as empirical functions of the number of crits.

The method used to calculate efficiencies by the crits method is to consider a specific core material, e.g., either oralloy or plutonium, and a given tamper. The efficiencies for various masses of core and a certain compression, which may be unity, are then calculated in any convenient manner, e.g., by the Bethe-Feynman formula. From the results, a curve expressing the variation of efficiency with the number of crits can be drawn. According to the arguments presented above, this curve should apply to all core-tamper systems of the same type, i.e., with the same core material (plutonium or oralloy) and the same ratio of the compressions (or densities) of core and tamper.

Since, for any core of mass  $M$  and compression  $C_c$ , the number of crits is given by equation (2.13), the efficiency of the corresponding fission weapon can be obtained directly from the curve. A different curve is used, of course, for each core material. Variations in the ratio of core-tamper compressions and in the neutronic thickness of the tamper are taken into account in estimating the critical mass. For composite cores, containing both plutonium and oralloy, semi-empirical adjustments are required to make the crits method applicable to such systems.

The crits method has been found to provide a rapid and reliable procedure for calculating efficiencies. Its main advantage over the Bethe-Feynman formula lies in the fact that the difficult and uncertain neutron theory calculations of  $\alpha$  and  $\delta$  for each case are avoided. The basic curve showing the variation of the efficiency with the number of crits is determined by applying the Bethe-Feynman formula to a simple system for which this formula is known to be reliable.

~~SECRET~~

UNCLASSIFIED

~~SECRET~~

UNCLASSIFIED

2.2 Factors Affecting Efficiency

Effect of Impurities on Efficiency

It was seen in Section 1.2 that the presence of impurities in the fissile material results in an increase in the critical mass. Hence, the number of crits present in a given mass of fissile material will decrease as the proportion of impurity increases. As seen above, a decrease in the number of crits means a decrease of efficiency. Consequently, the efficiency of a weapon will suffer appreciably if nonfissionable impurities are present. For this and other reasons, as will shortly be evident, it is desirable that the fissionable material be as pure as possible. Some indication of the effects on the energy yield of plutonium-240 as an impurity will be given below (Table 2.4).

Effect of Predetonation on Efficiency

The time at which the fission chain is initiated is of paramount importance in determining the yield of a given weapon.

There is a certain probability that the fission chain will be initiated during this period by a background neutron, but the chance that this will occur at optimum compression is very small. Consequently, it is essential that a neutron source, such as described in Section 1.5, be included to initiate the chain reaction at the proper time.

The effect of predetonation\* can be illustrated by reference to Fig. 2.2, in which the ordinates are either the number,  $N$ , of critical masses, i.e., crits, or  $\alpha$ , the multiplication

\*The term "predetonation" as used at LASL refers to initiation before maximum supercriticality. Preinitiation, used by some workers, would be a more appropriate term, but there appears to be little prospect of its general adoption.

~~SECRET~~

UNCLASSIFIED

DOE  
b(3)

DOE  
b(3)

UNCLASSIFIED

SECRET

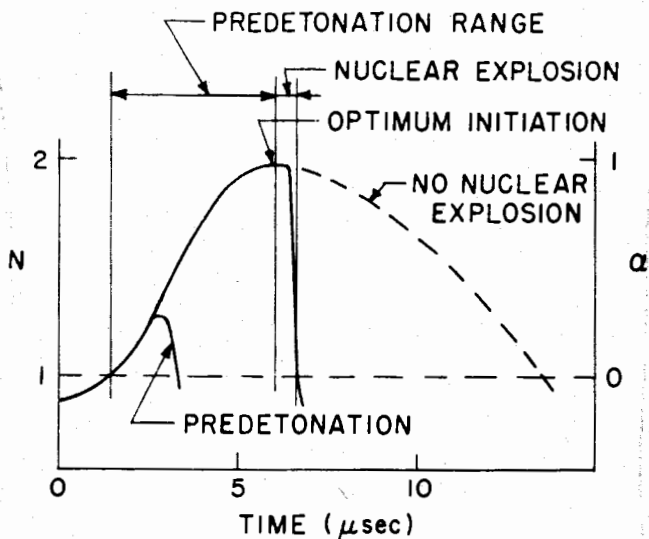

Fig. 2.2

rate, and the abscissae are elapsed time from the beginning of the assembly of a gun-type weapon or compression of an implosion weapon. The numerical values given for  $N$  and  $\alpha$  are not exact and are intended merely as an indication of the changes which occur. The times, on the other hand, are fairly representative of an implosion weapon. The horizontal dotted line represents the situation for a system that is just critical, i.e.,  $N = 1$ ,  $\alpha = 0$ . Actually, the curves for  $N$  and for  $\alpha$  as functions of time are somewhat different, and the maxima do not necessarily coincide. However, for the present qualitative discussion, a single curve is adequate.

At zero time the fissile material is subcritical, i.e.,  $N < 1$ , and  $\alpha$  is negative, but as compression (or assembly) occurs the value of  $N$  increases and  $\alpha$  becomes positive, i.e., the system becomes supercritical. If, for some reason, there were no nuclear explosion, the fissile material would suffer decompression, due to its elasticity, after reaching the compression maximum, as indicated by the broken line in Fig. 2.2. In the case of a gun weapon, the parts may fly apart due to the impact.

The optimum yield will obviously be obtained if initiation occurs at the maximum of the curve, i.e., when  $N$  has its maximum value. It is at this instant, a few microseconds after compression starts, that the chain should be initiated by the special neutron source. In this event, the whole nuclear explosion will be over in 0.25 to 0.75 μsec, as stated in Section 1.4.

If a neutron entered the core in the period between that at which  $N = 1$ ,  $\alpha = 0$  and the maximum of the curve, i.e., while the system is supercritical but before maximum supercriticality is attained, an explosion would occur, but since  $N$  would not be as large as is possible, the efficiency will be low. Thus, in order to attain the highest efficiency, predetonation must be avoided. The same will also be true, of course, for postdetonation, i.e., initiation after the maximum of compression has been passed.

The variation of yield with time of initiation may be calculated by any of the methods given above for the determination of efficiency. All that is necessary is to introduce the values of  $N$ ,  $\alpha$ ,  $\rho$ , etc., which are appropriate to the explosion time in each case. The values

UNCLASSIFIED

SECRET



~~SECRET~~

of  $\phi$  will, of course, pass through a maximum, corresponding to the instant of maximum supercriticality.

Oralloy: Neutron Background and Predetonation Probability

In view of the loss of efficiency that would result from predetonation, it is necessary to consider the question of background neutrons, due to spontaneous fission and to the action of alpha particles on light nuclei. Nuclear reactions of the latter type are referred to as ( $\alpha, n$ ) reactions.

Because of the relatively low rates of spontaneous fission of both uranium-235 and -238, the number of neutrons due to this cause in oralloy is very small. Further, as a result of the very long half lives of both these isotopes, the rate of alpha particle emission is very low. The third naturally occurring isotope, uranium-234, has a half life of  $2.35 \times 10^4$  years, and so emits alpha particles at an appreciable rate. This isotope is present to the extent of about 1.1 per cent in oralloy. However, the rate of neutron liberation in oralloy as a result of ( $\alpha, n$ ) reactions with light elements is not very large.

The total background neutron production in oralloy does not exceed about 2 neutrons/sec per kg.

If  $P_1$  is the probability that a background neutron will be available in the fissile material during the period that the core is supercritical, and  $P_2$  is the probability that this neutron will be able to start a fission chain, then the probability,  $P$ , of predetonation is given by

$$P = 1 - e^{-P_1 P_2} \approx P_1 P_2, \tag{2.14}$$

the approximate form being applicable when  $P_1 P_2$  is small.

It should be pointed out that  $P_2$  is a function of time and that both  $P_1$  and  $P_2$  depend, to some extent, on the position of the neutron and other variables. For the present purpose, which is to draw general conclusions only, specific values will be assigned to both  $P_1$  and  $P_2$ . A neutron may either escape from the system altogether, or be captured in a nonfission reaction, or produce fission. Although the probabilities of these three processes are by no means equal, it will be postulated here that  $P_2$  has an average value of 0.3 over the predetonation period, in all cases.

DOE  
b(3)

DOE  
b(3)

~~SECRET~~

DOE  
5(3)

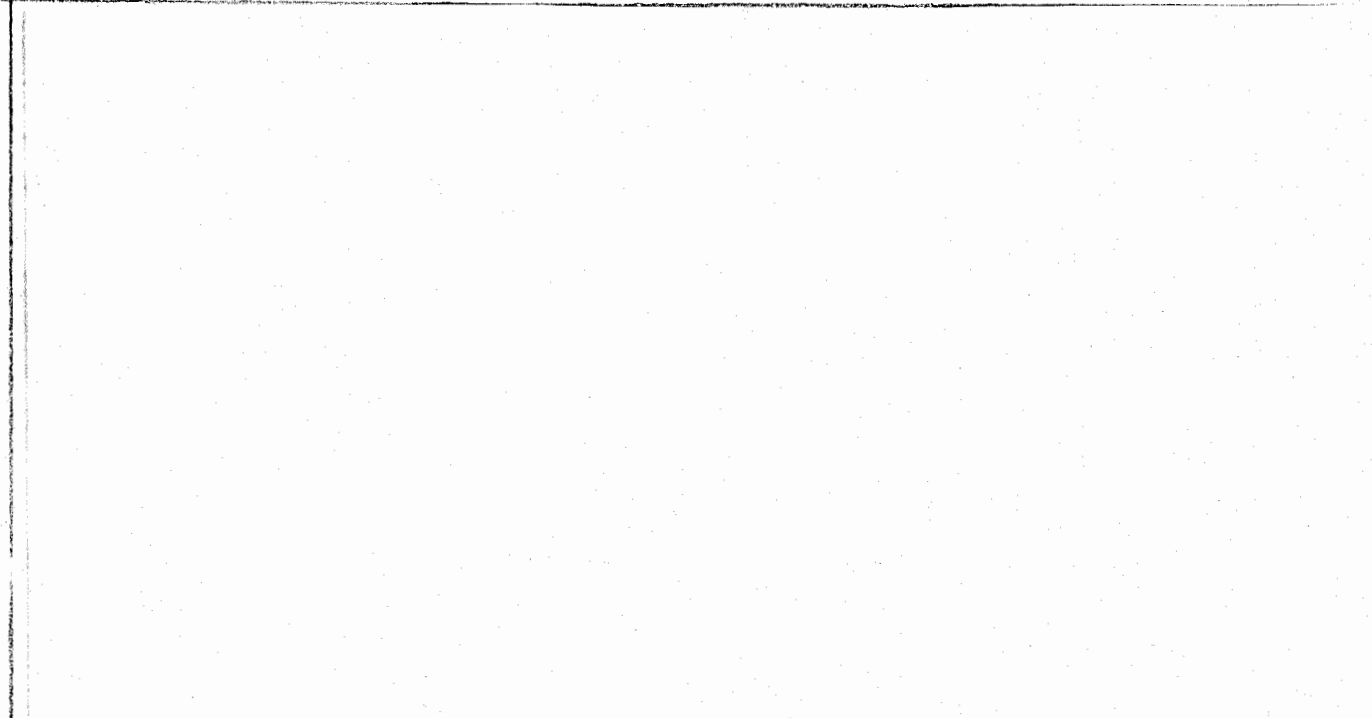

Tamper and Initiator Background

DOE  
6(3)

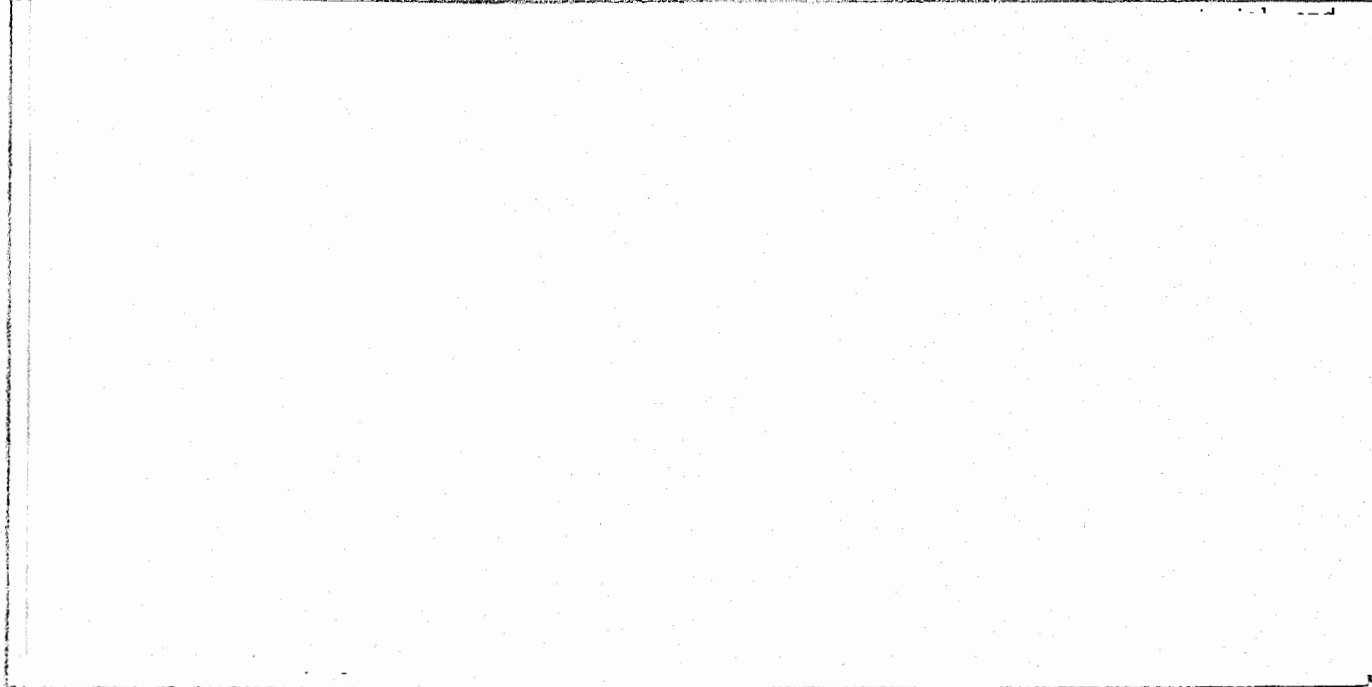

Plutonium: Neutron Background

With plutonium the situation as regards background neutrons is very different from that with or alloy. Not only is the spontaneous fission rate of plutonium-240 (an inevitable impurity)

UNCLASSIFIED

high, but, in addition, the moderately short half life of plutonium-239 means a considerable rate of alpha-particle emission which can lead to neutron production by ( $\alpha, n$ ) reactions.

The elements which have appreciable cross sections for ( $\alpha, n$ ) reactions are those with mass numbers of about 30 or less.

It should be noted that the amounts refer to each individual element if it alone is present. If there are several present, as will usually be the case, then if  $c_i$  is the concentration of the element  $i$  in parts per million, the sum of the  $c_i/q_i$  values for all the elements must not exceed unity, where  $q_i$  for each element is that given in Table 2.2.

Predetonation Probability with Plutonium

DOE  
b(3)

DOE  
b(3)

DOE  
b(3)

DOE  
b(3)

~~SECRET~~

UNCLASSIFIED

DOE  
b(3)



It is of interest to mention here that when the nuclear fission bomb was first planned, it was designed as a gun-type weapon, since it was felt that this would provide a simple and reliable method for rapidly attaining supercriticality. However, when plutonium became available in quantity, and the high background rate of neutron production due to spontaneous fission of plutonium-240 was discovered, a complete change of outlook was necessary. It was then that consideration was given to the much more difficult problem of converting a subcritical mass of fissile material to the supercritical system by compression in an extremely short interval of time by means of an implosion.

The chief difficulty anticipated in the design of an implosion weapon was the production of a shock wave having reasonably good spherical symmetry, so as to provide uniform and, hence, virtually instantaneous compression of a subcritical sphere of fissile material. When this problem was solved, by the methods to be described later, the smaller predetonation probabilities and the higher efficiencies attainable resulted in a concentration of attention upon weapons of the implosion type.

DOE  
b(3)



The smaller the permissible proportion of plutonium-240 in the fissile material, the shorter will be the exposure time, expressed in MWD/T, of the fuel elements in the production reactors (see Section 1.5). Consequently, material of low plutonium-240 content, i.e., with a low neutron background, will be both scarce and costly. It is desirable, therefore, in the design of implosion weapons to determine if plutonium of higher MWD/T values can be utilized.

DOE  
b(3)



UNCLASSIFIED

~~SECRET~~

~~SECRET~~ *MM*

*DOE  
b(3)*

UNCLASSIFIED

Effect of Background Neutrons and Material Dilution on Yield

The estimates of predetonation probabilities due to the presence of plutonium-240 have been intended only to give an indication of their orders of magnitude. |



in Chapter 4.

In addition to the yield loss from predetonation, i.e., the predetonation probability, which is statistical in nature and can be determined only as an average loss for a large number of bombs, there is another loss which occurs for each individual bomb. This is usually referred to as material dilution, and is due to the dilution of the plutonium by the less reactive 240-isotope.

The values are relative to the efficiency for plutonium containing none of the 240-isotope.

UNCLASSIFIED

~~SECRET~~

-46- *MM*

*DOE  
b(3)*

*DOE  
b(3)*

*DOE  
b(3)*

~~SECRET~~

UNCLASSIFIED

convergent (or implosion) wave. In order to insure maximum symmetry of the implosion wave the spread of firing times over the surface of the sphere must be very small.



This is largely because it appears that when only a limited space is available, it is better utilized in other ways, as will be explained later.



The implosion shock wave travels through the tamper and then strikes the core of the fissile material. As a result of the steadily decreasing volume into which the shock moves, there is a greatly increased concentration of shock energy, and a corresponding increase in compression, as the wave travels toward the center. The highest compression is thus attained in the core where it is needed. As the core is compressed in this manner the previously sub-critical mass becomes supercritical and a divergent fission chain can be maintained. When the shock wave arrives at the center of the core, it brings about activation of the neutron source or initiator. Consequently, neutrons are introduced into the core and the fission chain is initiated at a time close to the instant of maximum compression. As already seen, maximum compression is a reasonable criterion for optimum energy yield.

~~SECRET~~

UNCLASSIFIED

~~SECRET~~

DOE  
b(3)

UNCLASSIFIED

The large uncertainties indicated are due to differences in the results obtained by the two standard methods for determining bomb yields (see Chapter 6).

DOE  
b(3)



DOE  
b(3)

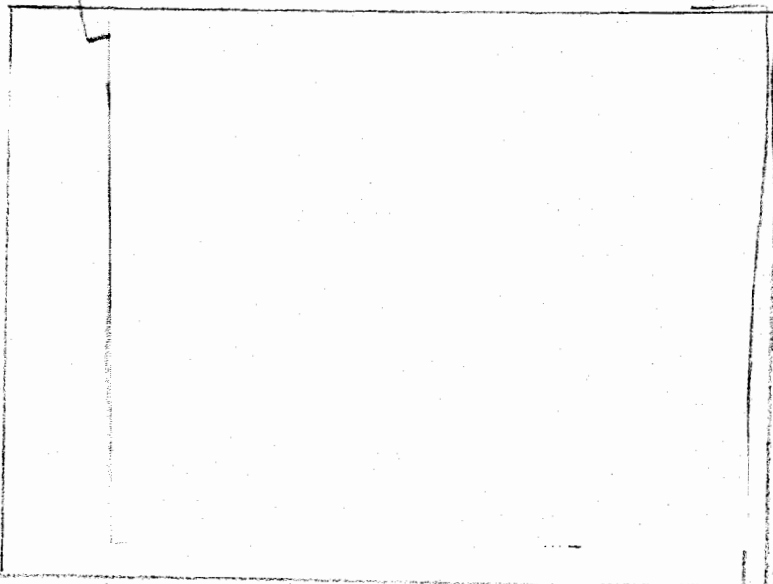

It is of interest to give some idea of the time scale in a fission bomb explosion. The elapsed time between firing the detonators and the initiation of the fission chain by the central neutron source is called the transit time.

Fig. 3.2

Principle of the Lens System

The fundamental laws underlying the propagation of detonation waves are analogous to those

DOE  
b(3)

UNCLASSIFIED

~~SECRET~~

~~SECRET~~

UNCLASSIFIED

b(3)

When the shock wave produced by the detonation of the HE inner charge enters the tamper, the latter moves forward, with the attached pusher, through the air space with increasing velocity. As a result, when the tamper reaches the core, it strikes the latter a tremendous, hammer-like blow. More energy is thereby transferred to the core, which is consequently more highly compressed than would be the case in the absence of a free run.

b(3)

Fig. 3.4

b(3)

Composite Cores

b(3)

UNCLASSIFIED

~~SECRET~~



b(3)

~~SECRET~~

b(3)

UNCLASSIFIED

This results from the fact that plutonium produces, on the average, about 2.9 prompt neutrons per fission, whereas uranium-235 yields about 2.5 neutrons. Because its chances of escape are less, a neutron originating in the center of the fissile core has a greater probability of causing fission than one produced in the outer portions. The over-all fission rate and energy yield are thus markedly dependent on the fission rate near the center of the core. Since plutonium produces more neutrons per fission than does uranium, it will have a higher  $k$  value, i. e., a high multiplication rate. Consequently, in a spherical core consisting of a plutonium center and an uranium outer region, the neutron density in the latter will be appreciably greater than if the core consisted entirely of uranium.

Fig. 3.5

b(3)

UNCLASSIFIED

Fig. 3.6

~~SECRET~~

b(3)

~~SECRET~~

UNCLASSIFIED

3.3 Design of Implosion Bombs

b(3)

The HE System

The design of an implosion bomb involves a combination of theoretical hydrodynamic calculations, performed with the aid of computing machines, empirical relationships, based on previous experience, and experimental tests of various components and assemblies. It is not necessary to treat the problem in detail here, and a general outline of the approach used will be sufficient.

b(3)

UNCLASSIFIED

~~SECRET~~

~~SECRET~~

UNCLASSIFIED

b(3)

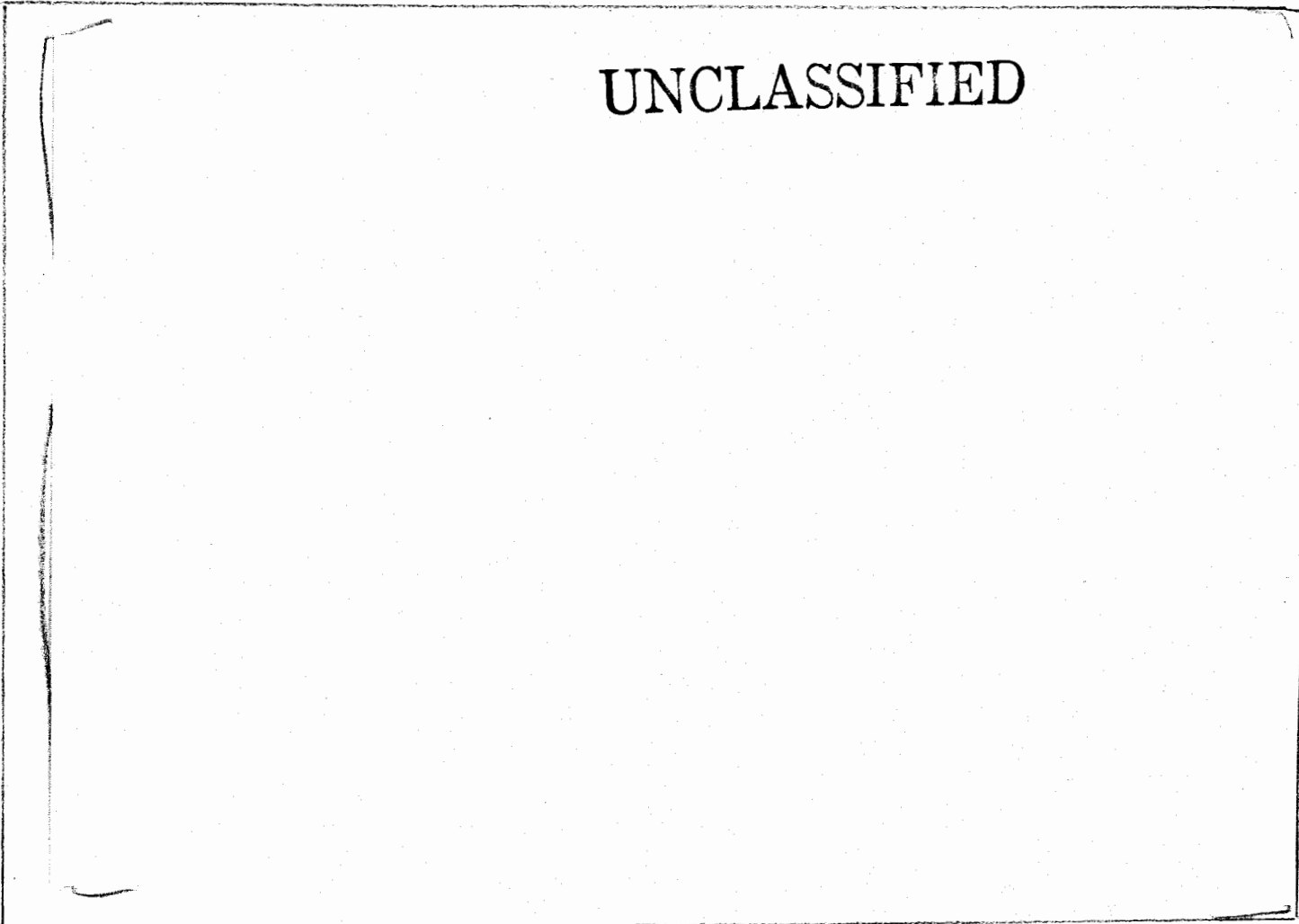

General Considerations

As indicated at the outset, the first step in the design of a new weapon, using accepted principles, is to make machine and other calculations based upon hydrodynamic theory and empirical data obtained in various tests and experiments. If the general results of these calculations appear promising, then the individual components are designed and tested individually and finally in various assemblies. The details of design and testing will be discussed in subsequent chapters.

It has been assumed, so far, that established and proven concepts are used in weapon design. From time to time, however, new ideas are proposed or old ones are revived.

b(3)

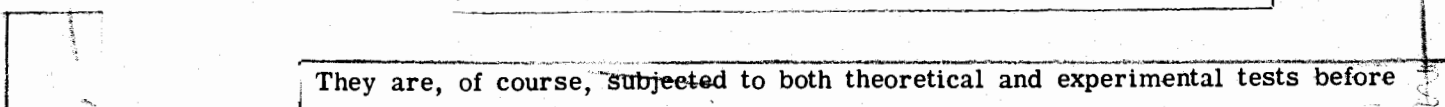

They are, of course, subjected to both theoretical and experimental tests before

b(3)



UNCLASSIFIED

~~SECRET~~

~~SECRET~~

a decision is made concerning their value and possible incorporation in new weapons. Some of these new principles will be examined below.

UNCLASSIFIED

3.4 Gun-Type Weapons

Components of Gun-Type Weapons

The design of gun-type weapons is a much simpler problem than is the case for implosion weapons.

The principle of the gun-type design may be understood from Fig. 3.10.

b(3)

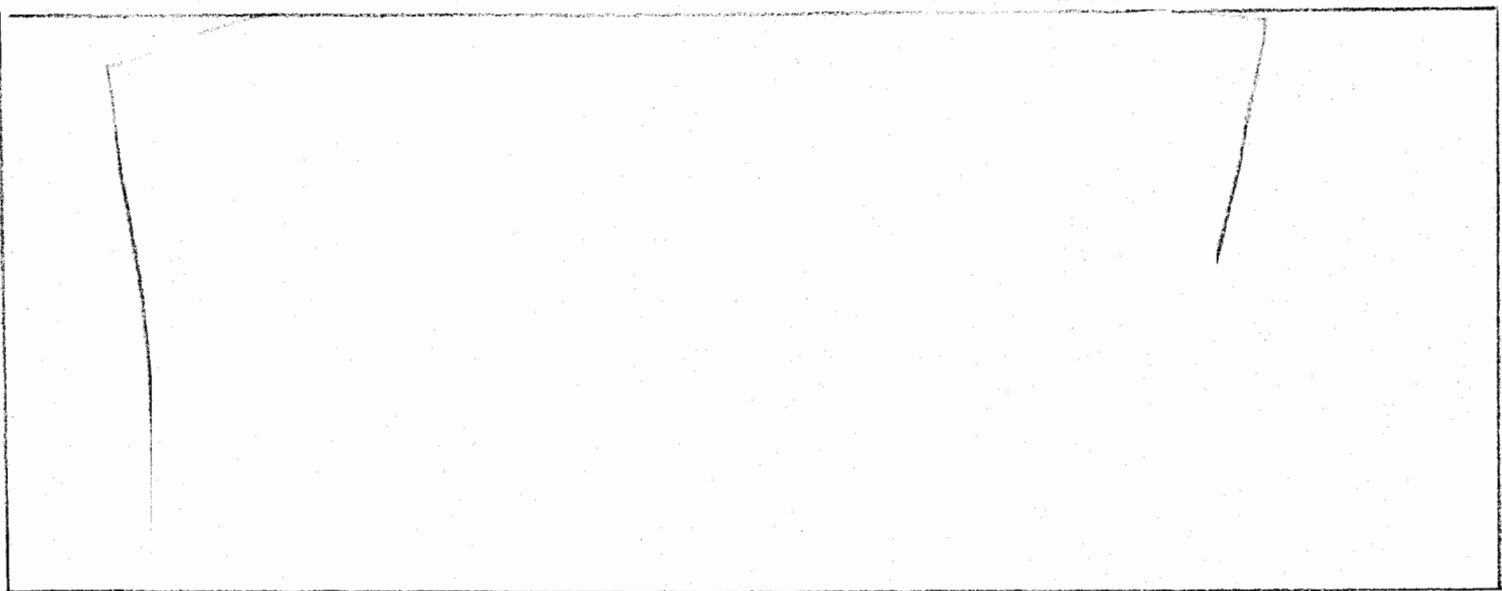

Fig. 3.10

b(3)

b(3)

In order to explode the weapon, the detonator, at the left end of Fig. 3.10, is fired and this causes ignition of the propellant.

When it is completely seated, the impact activates the polonium-beryllium initiator and neutrons are injected very close to the instant of maximum supercriticality. The fission chain is initiated and the weapon explodes.

b(3)

UNCLASSIFIED

~~SECRET~~

b(3)

~~SECRET~~

b(3)

UNCLASSIFIED

The tamper in the gun-type weapon serves two functions which are the same as in implosion weapons, i.e., neutronic and inertial tamping.

b(3)

The efficiency of a gun-type weapon is considerably less than that of an implosion weapon employing the same amount of fissile material. The absence of compression in the gun-type weapon is the primary reason for this difference.

b(3)

While the fundamental design principles of the gun-type weapon have remained essentially unchanged, a number of improvements have been introduced and proposed. These will be referred to in Chapter 5, where the constructional details of various forms of this weapon are described.

Design of Gun-Type Weapons

Because of their lower efficiency and, apparently, limited range of energy yield, as compared with implosion bombs, the design of gun-type weapons has not received great attention.

b(3)

UNCLASSIFIED

~~SECRET~~

~~SECRET~~

UNCLASSIFIED

b(7)

impurities as in oralloy, the background is estimated to be 35 to 50 neutrons/sec per kg, as compared with a total of 2 neutrons/sec per kg for oralloy. Nevertheless, the former value is very much less than for 200 MWD/T plutonium, which has a background of 16,000 neutrons/sec per kg.

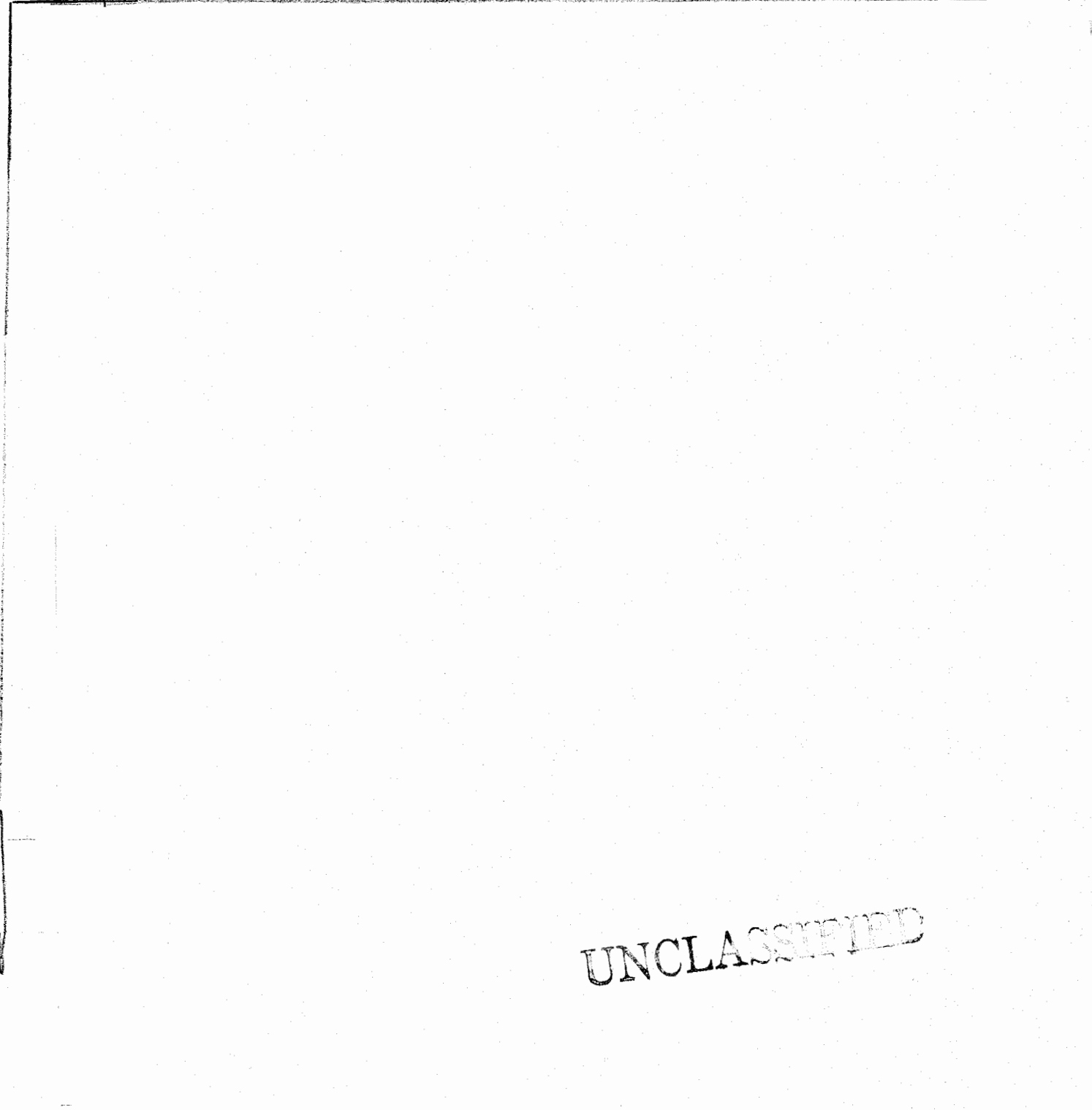

UNCLASSIFIED

~~SECRET~~

~~SECRET~~

UNCLASSIFIED

b(3)

3.6 Boosting

General Principles

b(3)

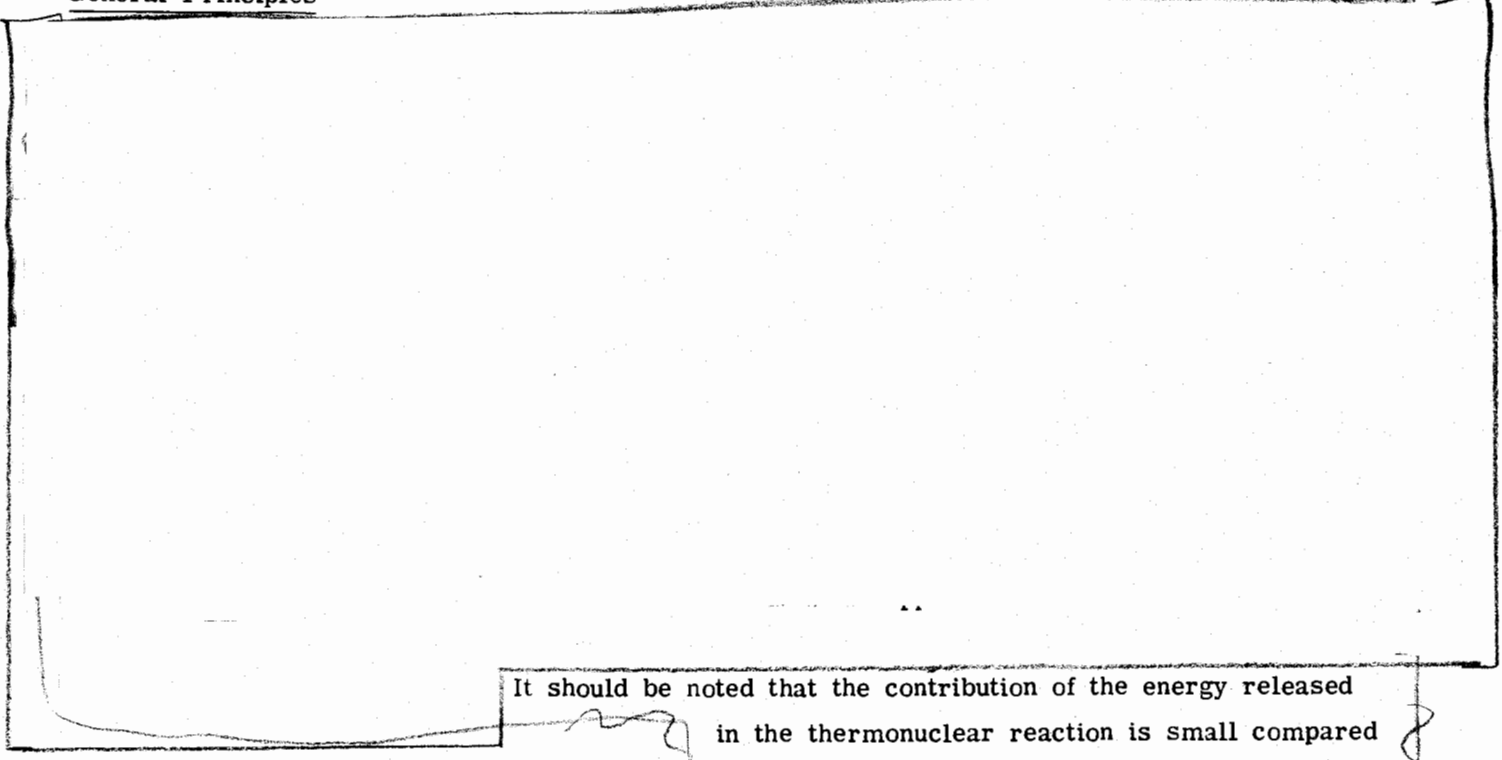

It should be noted that the contribution of the energy released in the thermonuclear reaction is small compared with that produced by fission.

UNCLASSIFIED

~~SECRET~~

b(3)

~~SECRET~~

UNCLASSIFIED

b(3)

Finally, the average number of neutrons released in fission by 14-Mev neutrons is more than four. Since this is larger than the normal values given in Table 1.1, there is a consequent further addition to the neutron population.

b(3)

The ratio of the efficiency (or yield) of a boosted device to that for the same device without boosting, is called the boosting factor.

Tests of Boosting

b(3)

The first test of boosting was made in the Item shot (Greenhouse, 1951).

UNCLASSIFIED

~~SECRET~~



b(3)

UNCLASSIFIED

As a result of field tests by the military, it was found that the 1E22 detonator would not withstand rough handling. Consequently, some constructional changes have been made to provide additional mechanical strength. The new form is being called the 1E25 and it is proposed for use in conjunction with ring lenses in the TX-13 bomb which is not yet in production.

b(3)

As a result, the 1E23 was produced.

As a re-

b(3)

A section through the middle of a 1E24 detonator is shown in Fig. 4.3.

b(3)

UNCLASSIFIED

Fig. 4.3

~~SECRET~~

b(3)

UNCLASSIFIED

Since simultaneity is an important requirement of a set of detonators, special care is taken to insure uniformity in the composition and density of the explosive materials. The dimensions of these substances in the detonator and of the bridge wire must be exact, within close tolerances. The necessity for careful control of all components involves numerous inspections at all stages of production.

Detonator Testing

Prior to assembly, the parts of a detonator are gaged and the head, containing the electrical connections, is examined radiographically to detect internal faults, as will be described shortly. When assembled, the detonator is inspected visually, important external dimensions are gaged, and the resistance of the bridge wire is measured. A selected number of detonators are then subjected to destructive testing.

Three types of firing tests are performed; these are determination of (a) simultaneity, (b) transit time, and (c) threshold (or minimum) voltage required to detonate the bridge wire. The detonators are manufactured in lots of about 1250 under conditions which should make them as nearly identical as possible. Of each lot, 132 are selected at random for destructive testing: 112 for simultaneity, 10 for transit time, and 10 for threshold voltage. This number is regarded as being large enough to represent a good sample.

Simultaneity is investigated by the rotating mirror camera method (RMC)\* which will be explained with the aid of Fig. 4.4. A set of 28 detonators and two bare bridge wires are placed horizontally, in a direction perpendicular to the plane of the paper. The purpose of the two bridge wires is to provide fiducial or reference points for timing purposes. The detonators and bridge wires are attached to a special X-unit of precision construction, so that they can be fired simultaneously. When the shock wave emerges from the detonator after firing, light is produced and this is focused by the objective lens system onto a horizontal slit, parallel to the line of detonators.

b(3)

UNCLASSIFIED

\*This rotating mirror camera is also called a "smear" or "streak" camera or a Bowen-type camera; however, the original Bowen device was not a smear camera, but a high-speed framing camera using a rotating mirror.

76 -  
~~SECRET~~

~~SECRET~~

UNCLASSIFIED

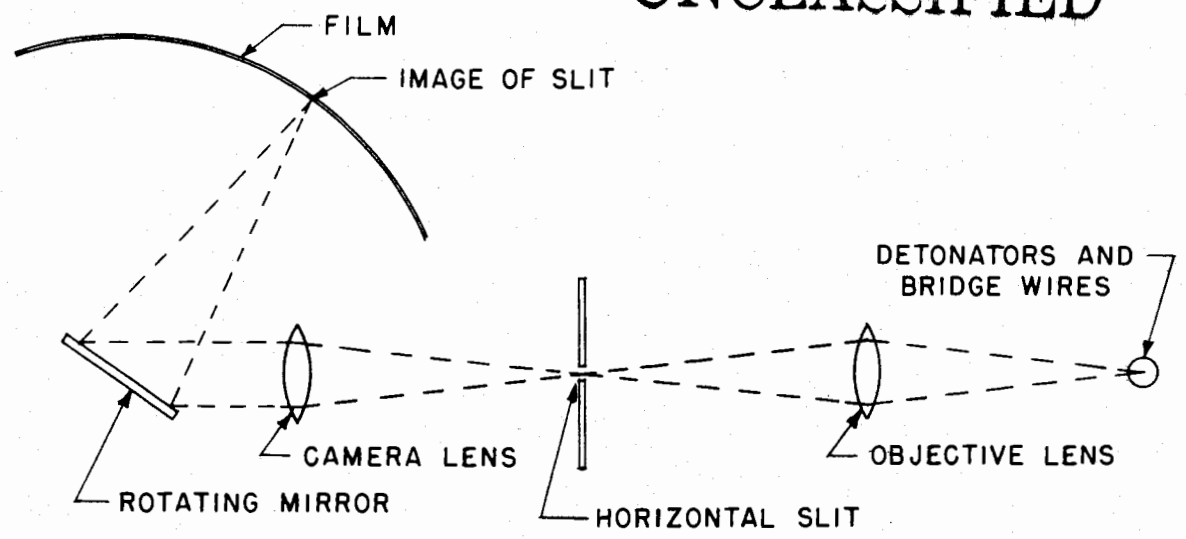

Fig. 4.4

As the mirror rotates, the first light picked up is that from the two bare bridge wires, and these leave traces (or streaks) on the film, which appear after development. There is then an interval during which the detonation waves are traveling through the 28 detonators. As each wave emerges from the face of the detonator, the light emitted produces its effect on the film. If all the detonators fired absolutely simultaneously, then all detonator streaks would start at precisely the same level on the film, and any deviations from simultaneity can be readily detected. From a knowledge of the rate of rotation of the mirror, and the distance from it to the film, displacement of the streaks on the film can be converted into intervals of time.

b(3)

The procedure described above is carried out with four groups of 28 detonators, and failure of any one of the 112 to fire, or inability to meet the simultaneity specifications given above, results in rejection of the complete lot of 1250 or so detonators. It is for this reason that the lots are not made too large, yet sufficiently large for a reasonable number to remain after removal of samples for testing.

Although the primary purpose of the rotating mirror camera procedure is to test simultaneity, it can be used to determine the time elapsing between bursting of the bridge wire and

~~SECRET~~

UNCLASSIFIED

somewhat as in Fig. 4.6. Since the fixed time interval is known, the transit time of the de-

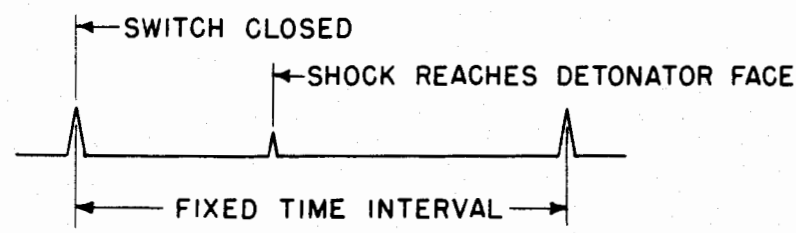

Fig. 4.6

tonator, between closing the firing switch and the appearance of the shock wave at the face, can be determined.

[Redacted]

It should be noted that the transit time includes the interval between closing the switch and the explosion of the bridge wire; this differs somewhat from the value obtained by the RMC method, since in the latter case the fiducial signal is provided by the exploding bridge wire.

[Redacted]

If the detonator fails to fire, it is replaced by another,

as the bridge wire will undoubtedly have been destroyed.

[Redacted]

Radiographic Testing

In the radiographic testing of detonators, X-rays of relatively low voltage (40 to 120 kv) pass through the object to be examined and then fall on a radiographic film, which is subsequently developed. The procedure is, in fact, exactly similar to that employed in medical and dental radiographs. The plastic head of every detonator, which contains the bridge wire and its connections, is examined by this method for internal defects that cannot be seen or detected in any other way. Two radiographs are taken from two directions at right angles, so that the positions of various components can be determined.

~~SECRET~~

UNCLASSIFIED

(b)(3)

Thus, in the noncritical region some reliance is placed on the judgment of the observer.

#### Environmental Tests

Because detonators may be required to operate under extreme conditions of temperature, humidity, altitude, etc., as dictated by military expediency, they are subjected to a variety of so-called environmental tests. For example, they are test fired at both very low temperatures, e.g.,  $-65^{\circ}\text{F}$  and sometimes as low as  $-90^{\circ}\text{F}$ , and at very high temperatures, e.g.,  $165^{\circ}\text{F}$ , after being maintained at these temperatures for some time. The effects of short exposures to very high temperatures, to which a nuclear fission warhead in a guided missile might be exposed, are also examined. The detonators must operate at high altitudes, up to 35,000 feet,\* and over a considerable range of humidities.

The effect of storage in various climates is investigated by artificial simulation of the conditions. This includes temperature cycling, equivalent to the day and night variations that might be encountered in arctic, tropic, and desert regions.

Extensive and continuous testing is performed to determine the effect of temperature and humidity on the life of a detonator in storage. This insures that stockpiled detonators have not deteriorated. Non-propagating storage cases have been designed, so that if one detonator is accidentally set off, the others in the case will not be affected.

As an aspect of the environmental testing, detonators have been subjected to gasoline fires and hot oil. Although burning occurred, there was no explosion. The effect of impact has been studied and the results show that the detonators are remarkably safe. Some tests have been made with the HE system of a Mark 7 having the projecting 1E23 detonators installed. Five complete HE assemblies were dropped from a height of 40 feet on to a thick steel slab backed

\*The firing system (X-unit) will not function at substantially higher altitudes, because leakage occurs due to electrical discharges at low pressures.

UNCLASSIFIED

~~SECRET~~

by concrete. A few detonations of a low order occurred, which may have been due to the fast component (Composition B) of the lenses. The lenses and HE inner charges suffered severe mechanical damage; so also did many of the detonators but they did not explode. In a similar impact test with five Mark 12 HE assemblies, with buried (1E24) detonators, there was no indication of either detonation or burning of the detonators or HE inner charge, although mechanical damage was considerable.

4.3 The Lens and Inner Charge System

Lens Design

b(3)

b(3)

b(3)

b(3)

~~SECRET~~

b(7)

The Ring Lens

UNCLASSIFIED

b(7)

b(7)

Fig. 4.13

UNCLASSIFIED

b(7)

~~SECRET~~

HE Components of Lenses

The fast-explosive component, which has remained almost unchanged throughout the development of implosion weapons, is known as Composition B. It consists of 60 parts by weight of RDX and 40 of TNT (trinitrotoluene). \* In addition to being a stable but powerful explosive, it is readily available. The detonation velocity of Composition B in rod form, i.e., the so-called "stick rate," is about 7900 meters/sec, and although explosives with higher detonation velocities are available, so that the refractive index may be increased, they have various drawbacks, with regard to stability, fabrication, handling, availability, etc., as compared to Composition B.

b(3)  
UCNI

UNCLASSIFIED

\*In order to introduce some system into the naming of explosives, it has been proposed to refer to Composition B as cyclotol 60/40. By convention, a name ending in "ol" indicates the presence of TNT.



~~SECRET~~

UNCLASSIFIED

main headings: a) physical methods, (b) analytical techniques, (c) radiographic methods, and (d) test firing. In addition, environmental tests, similar to those described for detonators, are made with samples of lens systems and inner charges.

b(3)

b(3)

Analytical techniques are destructive in nature and are concerned with a detailed examination of a number of samples obtained from different parts of a single piece. Determinations are made of density and composition to insure uniformity. These are, of course, important factors in connection with the symmetry of the spherical implosion wave.

b(3)

Radiographic methods are employed both for quality control and to determine acceptability. They are nondestructive and are consequently applied to all finished products, as well as in some intermediate stages. Because the heavy element barium is rather opaque to X-rays, radiations

b(3)  
CONF

b(3)  
CONF

~~SECRET~~

UNCLASSIFIED

~~SECRET~~

b(3)

UNCLASSIFIED

Inner charges are examined radiographically for cavities, impurities, and defects of various kinds. The whole of the inner charge is important and so there are no noncritical regions. Since inner charges are not subjected to routine firing tests, as are lenses, the radiographic procedure acquires special significance. However, the performance (or quality) of inner charges is determined indirectly in the course of other measurements, to be described below.

The radiographic technique is primarily applicable to the detection of discrete defects having definite boundaries.

b(3)  
SECRET

For a given material, this absorption will depend on the product of the thickness and density; thus, it may be possible to detect, in a nondestructive manner, gradual changes of density which cannot be observed radiographically.

Test Firing of HE Lenses

The purpose of test firings is to determine the transit time of a lens, i.e., the time for the detonation to travel from the face of the detonator to the lower face of the lens, and also to study the variations, if any, in emergence time of the shock wave at points across the face. For this test, anywhere from 2 to 10 per cent of the lenses of a given batch are selected so as to form a representative sample.

b(3)

Each gap forms part of an electrical circuit, so that when the shock front reaches the gap, the ionization produced causes a condenser to be discharged and a signal is transmitted to a rasterscope (or raster oscilloscope). This instrument gives a series of traces, each successive one below the other, over a period of time; accurate time interval pulses are superimposed on the rasterscope pattern. A schematic representation of the electrical circuit is given in Fig. 4.18.

~~SECRET~~

UNCLASSIFIED

~~SECRET~~

UNCLASSIFIED

b(3)

When the detonator is fired, the ionization due to the shock wave emerging from its base discharges one condenser, and this causes a deflection on the rasterscope trace. Then as the wave proceeds and emerges from the face of the lens, the second condenser is discharged, and a second deflection appears.

The distance between the two deflections on the trace, which is recorded by means of a camera, is then a measure of the transit time of the detonation wave through the lens. The actual transit time is obtained by making use of superimposed time pulses on the rasterscope trace. Some experimental values of transit times for various HE systems are given in Table 4.1 (below).

Simultaneously with the performance of the foregoing measurements, of transit times, the emergence times of the luminous detonation front at points across the lens face are being studied by means of rotating mirror (streak) camera. The

procedure is exactly similar to that described in Section 4.2, for the testing of detonators.

The slit shown in Fig. 4.19 is arranged so that the camera picks up the light from a strip across the middle of the face of the lens.

If the luminosity appeared at exactly the same instant across the whole lens face, the developed film would show a dark streak with a sharp, straight boundary. Actually, because of the variations in emergence times of the shock front, the boundary shows irregularities. By magnifying the image from the film, it is possible to determine accurately the emergence times at a series of points across the lens face, with reference to the earliest emergence time. The results are then represented graphically with the time as abscissae and the

~~SECRET~~

UNCLASSIFIED

~~SECRET~~

b(3)

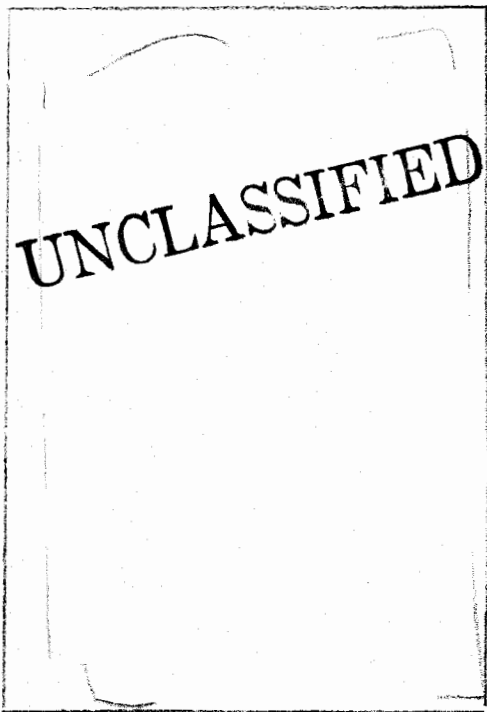

Fig. 4.20

studied, since the lens may not have axial symmetry. An approach to this ideal has been made by using a number of parallel slits, in place of a single slit, so that the whole face is essentially covered at the same time. However, the ordinary rotating mirror method cannot be used without modification because the various streaks would overlap.



The

streaks obtained by the rotating mirror camera from several slits simultaneously are thus quite narrow and there is no overlap.

The technique involved in the multislit method is somewhat complicated, and so it is not generally used for lens testing. Its main application so far has been in an experimental study of the time spread, over a fairly large area, of the detonation wave as it leaves the lens and passes through various thicknesses of I.C.

Environmental Tests of Lenses and Inner Charges

As described in Section 4.2 for detonators, both lenses and inner charges are subjected to low (-90°F) and high (165°F) temperatures and also to temperature and humidity variations such as might be encountered under arctic, tropic, or desert conditions. Examination is made for significant changes in dimensions, for mechanical damage, e.g., stress cracks, and for the appearance of excessive exudation from the HE materials. Tests are being planned in which the HE system will be fired at both temperature extremes to determine the relationship between temperature and transit time.

Summary of HE Systems

For convenient reference, a summary of the characteristics of the HE systems in stockpile, in production, or which will soon be production, is given in Table 4.1.

b(3)

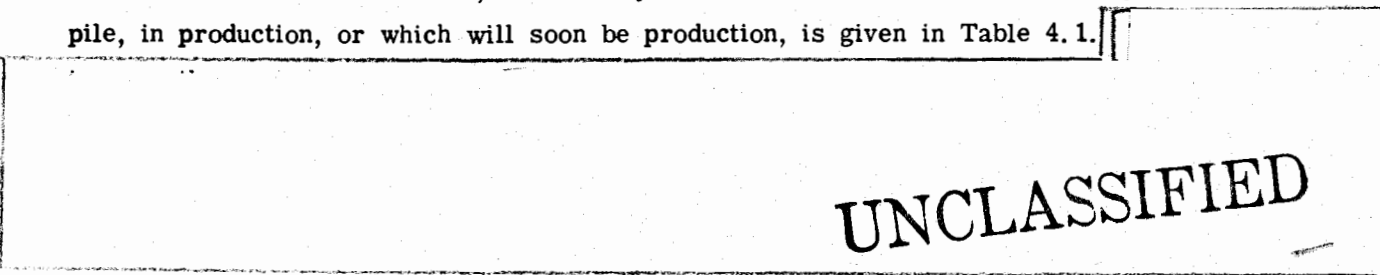

~~SECRET~~

Photographic Methods

In the study of implosion phenomena, photographic methods are chiefly applied to investigate the motion of metal surfaces, e.g., of the tamper or ball. In this way, the effects of perturbations in the detonation wave and in the shock wave, which may be due to the supporting structure for the ball, may be examined. Although the photographic technique is not generally employed for routine testing or design, it is used in trying out new ideas. For this purpose, a simple, rapid, and inexpensive procedure has been developed.

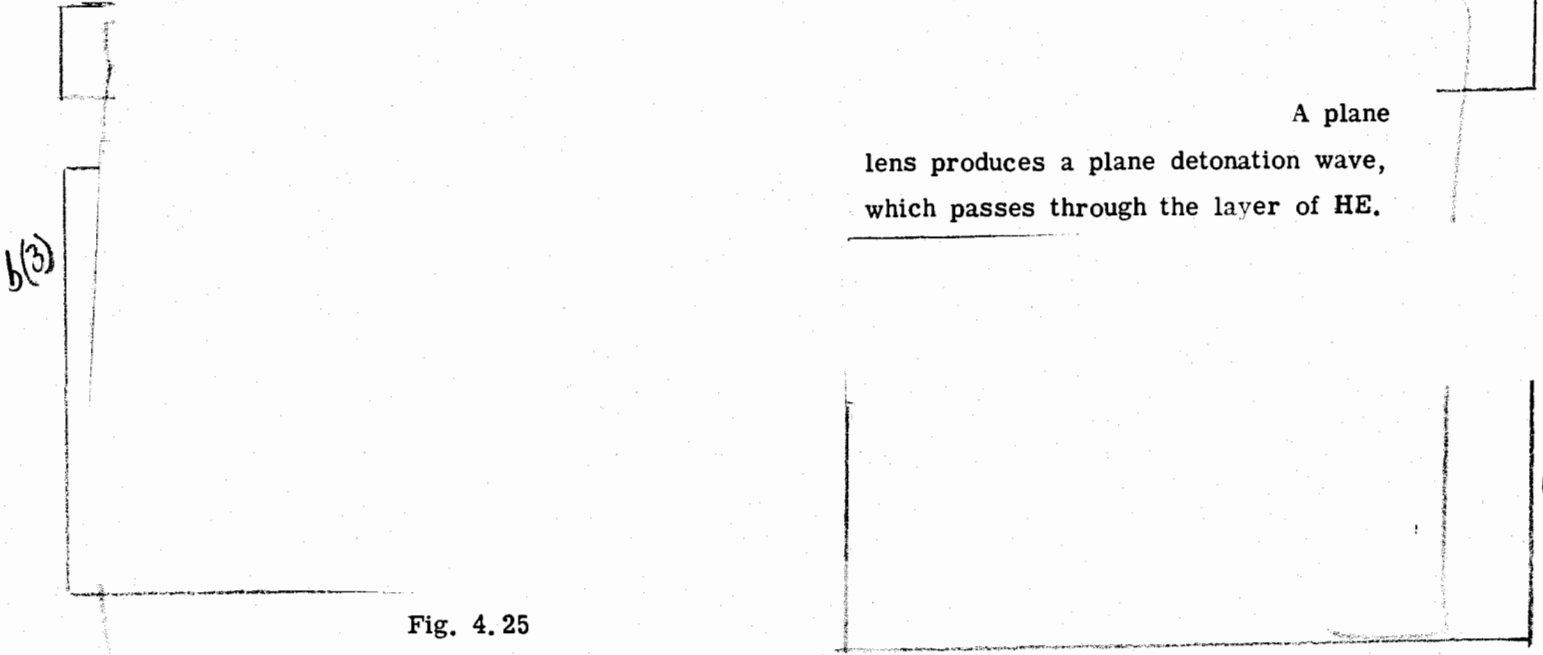

Fig. 4.25

The rate and uniformity of the movement of the free surface is studied by drawing a rectangular grid pattern on the lower surface of the plate.

Advanced models of this rotating mirror camera have been designed which will take pictures at rates up to 3.5 million per second. The intense illumination of short duration required for these very brief exposures is obtained by passing a shock wave, produced by a detonation in HE, through a column of argon.

The plane lens and the HE used to produce the flash in argon are fired simultaneously, and a series of photographs of the grid, either perpendicularly or at a slant angle, are taken by the high-speed camera. From the pictures made at an angle it is possible to calculate the free surface velocity of the metal plate. In addition, from an examination of the grid, preferably in a direct view, qualitative information can be obtained concerning the symmetry of the shock wave. Results secured in this manner can be confirmed, if necessary, by means of a spherical implosion system with a grid drawn on a hemispherical surface.

~~SECRET~~

UNCLASSIFIED

In addition to the procedure just described, high-speed photography is used to produce profile shadowgraphs, i. e., edge-on views, of a plate subjected to the action of a shock wave. Information concerning departure from uniformity of motion can be detected in this manner.

On the whole, high-speed photography is best suited to qualitative studies; it is particularly valuable in providing a physical picture of the effects of a shock wave produced in a given manner. If more exact quantitative data are required the rotating-mirror streak camera, described in Section 4.2, is used to amplify the observations. The multiple slit procedure, referred to in Section 4.4, can provide quantitative information concerning leads and lags in the shock front at free surfaces. The photographs obtained with the high-speed framing camera facilitate the interpretation of the streaks.

High-speed, flash photography, like the other two methods of studying implosion effects, is used to derive equation of state data for metals at high pressures for theoretical calculations. In fact, this is the main application at the present time. Fortunately, the three procedures do not duplicate one another, as each is best suited to a particular range of pressures.

b(3)

The photographic technique is then particularly convenient, as described above.

#### Radar Technique

A proposal for the use of radar in the study of the rate of propagation of the detonation wave, and the effect upon it of convergence, in the inner charge system is under development. Due to the ionization it produces, the surface of a detonation wave is a good electrical conductor and so reflects radar waves, i. e., electromagnetic waves of short wave length, about 3 cm. Because the detonation front is in motion, the frequency of the reflected radar waves differs from that of the incident waves, as the result of a type of Doppler effect. From the beat frequency arising from the combination of incident and reflected waves, the velocity of the detonation front can be determined.

UNCLASSIFIED

~~SECRET~~

~~SECRET~~

UNCLASSIFIED

Chapter 5

Components Design and Testing: The Nuclear System

5.1 Pit and Capsule Characteristics

Pit and Capsule Defined

The portion of an implosion bomb lying within the HE system consists essentially of two components: the pit and the capsule.

b(3)

b(3)

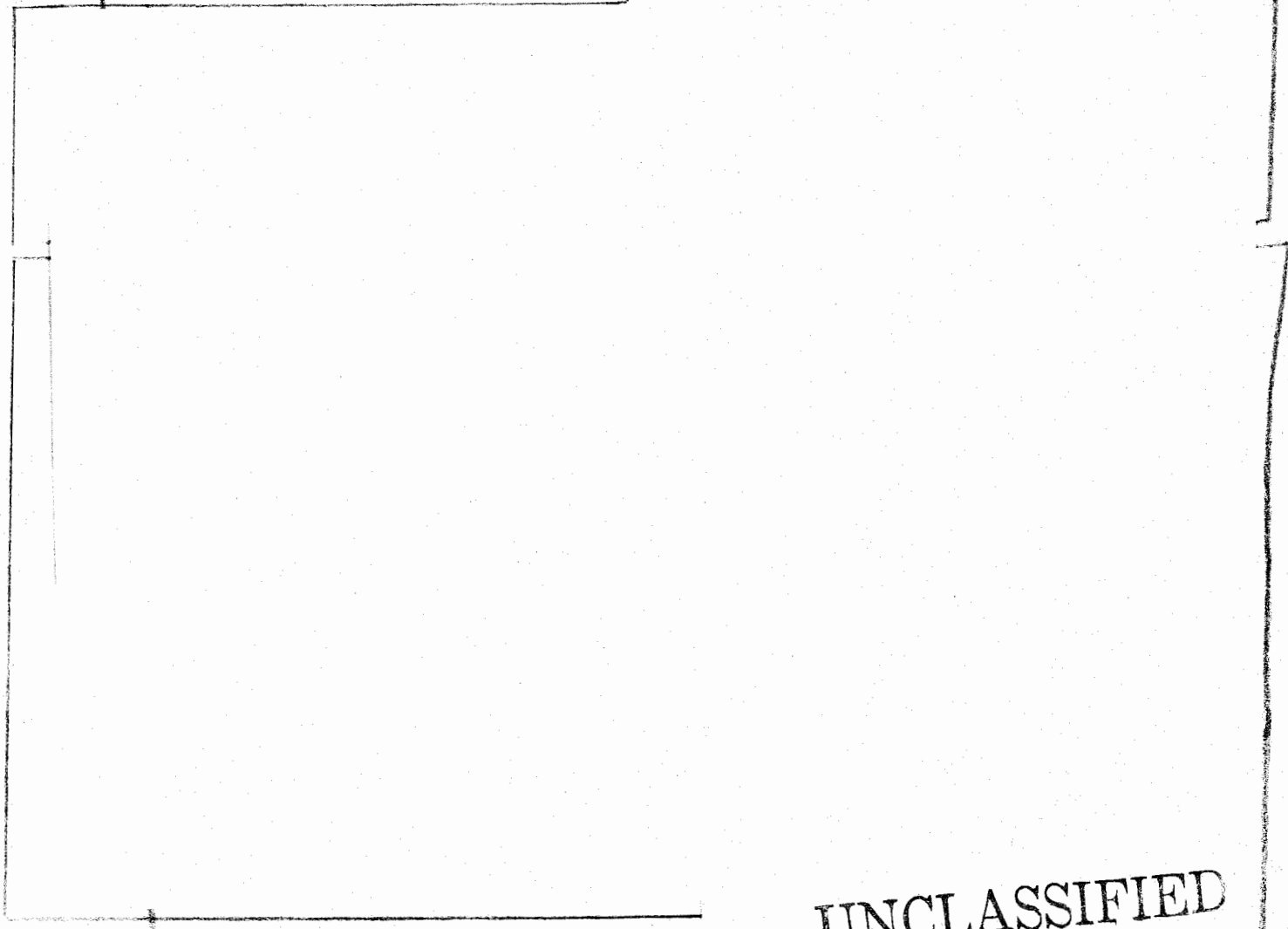
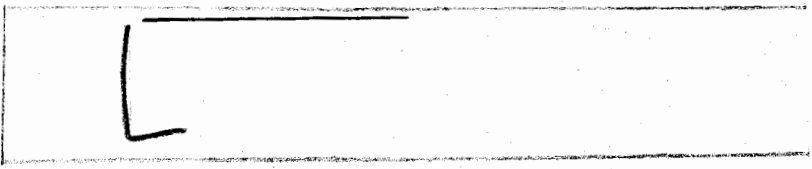

Fig. 5.1

UNCLASSIFIED

b(3)



~~SECRET~~

~~SECRET~~

UNCLASSIFIED

b(3)

[Redacted]

If the final positioning of the capsule within the pit is performed while the weapon is airborne, the process is referred to as "in-flight insertion," abbreviated to IFI.

Characteristics of Pits

b(3)

[Redacted]

Some of the important characteristics of the pits referred to above are summarized in Table 5.1.

b(3)

[Redacted]

Table 5.1 Characteristics of Pits

[Redacted]

Characteristics of Capsule Balls

UNCLASSIFIED

b(3)

~~SECRET~~

b(3)



~~SECRET~~  
UNCLASSIFIED

b(3) For reasons connected with the limited life of the neutron (polonium-beryllium) source which initiates the fission chain, capsule balls must be disassembled from time to time and provisions for this must be made in their construction.

b(3) The outer radii and compositions of the capsule balls are given in Table 5.2; the percent plutonium indicates the proportion this element represents of the total fissile material.

b(3) Table 5.2 Characteristics of Capsule Balls

b(3) UNCLASSIFIED

~~SECRET~~

UNCLASSIFIED

to plutonium metal; an argon atmosphere is maintained to prevent oxidation of the latter. Considerable heat is evolved in the chemical reactions which occur, and metallic plutonium, melting point 635°C when pure, drops to the bottom of the crucible and is removed as a button upon cooling. It is of interest to mention that all the foregoing processes are now performed by remote control.

Because the critical mass of plutonium is greater in the absence of water, it is permissible to operate with larger quantities in the dry stages. Thus, clean plutonium turnings or filings, obtained from metal fabrication processes, are added either to the fluorination or to the reduction stages for recovery. The metallic buttons obtained may weigh up to 750 grams.

During the reduction process gallium metal is added to form a plutonium-gallium alloy containing 1 per cent by weight of the latter element. The purpose of the gallium is to stabilize the plutonium in the delta-phase form.

UNCLASSIFIED

~~SECRET~~

b(3)

b(3)

~~SECRET~~

UNCLASSIFIED

If the plutonium hemispheres pass the foregoing tests they are then examined radiographically and by autoradiography. The radiographic test, using gamma rays from cobalt-60, will detect the presence of cavities, cracks, etc. If these are in excess of a certain minimum size and number, the part is rejected.

b(3)

Oralloy Production and Fabrication

As stated in Chapter 1, oralloy, in the form of uranium hexafluoride, is obtained from the gaseous-diffusion plants. It is then of sufficient purity not to require further processing before reduction to metal, by the method given in Section 1.5. Nevertheless, the material is analyzed to make sure that the light-element impurities are not excessive. The metal, which does not have such good metallurgical properties as delta-phase plutonium, is fabricated by vacuum casting followed by machining to shape.

b(3)

UNCLASSIFIED

~~SECRET~~

b(3)

~~SECRET~~

# UNCLASSIFIED

## Recovery of Plutonium and Oralloy

Because of their value as fissile materials, all residues of plutonium and oralloy are carefully collected for recovery. Plutonium in the form of metal, e.g., turnings, filings, etc., or of oxide, formed in casting, is dissolved in nitric acid with a little hydrofluoric acid. From the resulting nitrate solution (or slurry), plutonium peroxide is precipitated by hydrogen peroxide and sent to the plutonium production line. Magnesium oxide crucibles and molds and the calcium fluoride-iodide slag remaining from the metal reduction stage are dissolved in nitric acid containing aluminum nitrate. The plutonium is then recovered either by direct extraction in tributylphosphate (TBP) diluted with kerosene, or extraction after an intermediate stage involving volume reduction by precipitation of the plutonium with calcium oxalate as carrier. Organic matter such as clean-up paper, rags, etc., are first incinerated and the residual ash is then treated as just described.

Oralloy turnings and oxide residues are dissolved in nitric acid and after two stages of precipitation with hydrogen peroxide, to insure high purity, the resulting uranium peroxide is converted mainly to  $U_3O_8$  by heat and is then reduced by hydrogen to the dioxide,  $UO_2$ . The action of hydrogen fluoride gas converts this to the tetrafluoride and the metal is finally obtained by heating with calcium. Magnesium oxide crucibles, slag, and other residues are treated in a manner similar to that used to recover plutonium. The materials are dissolved in nitric acid with aluminum nitrate and the uranium is extracted by means of TBP in kerosene.

UNCLASSIFIED

~~SECRET~~

~~SECRET~~

UNCLASSIFIED

5.4 The Fission-Chain Initiator

b(3)

The Tom Initiator



The initiators in general use produce neutrons by the ( $\alpha, n$ ) reaction upon beryllium, with polonium as the source of the alpha particles (Section 1.5).

b(3)

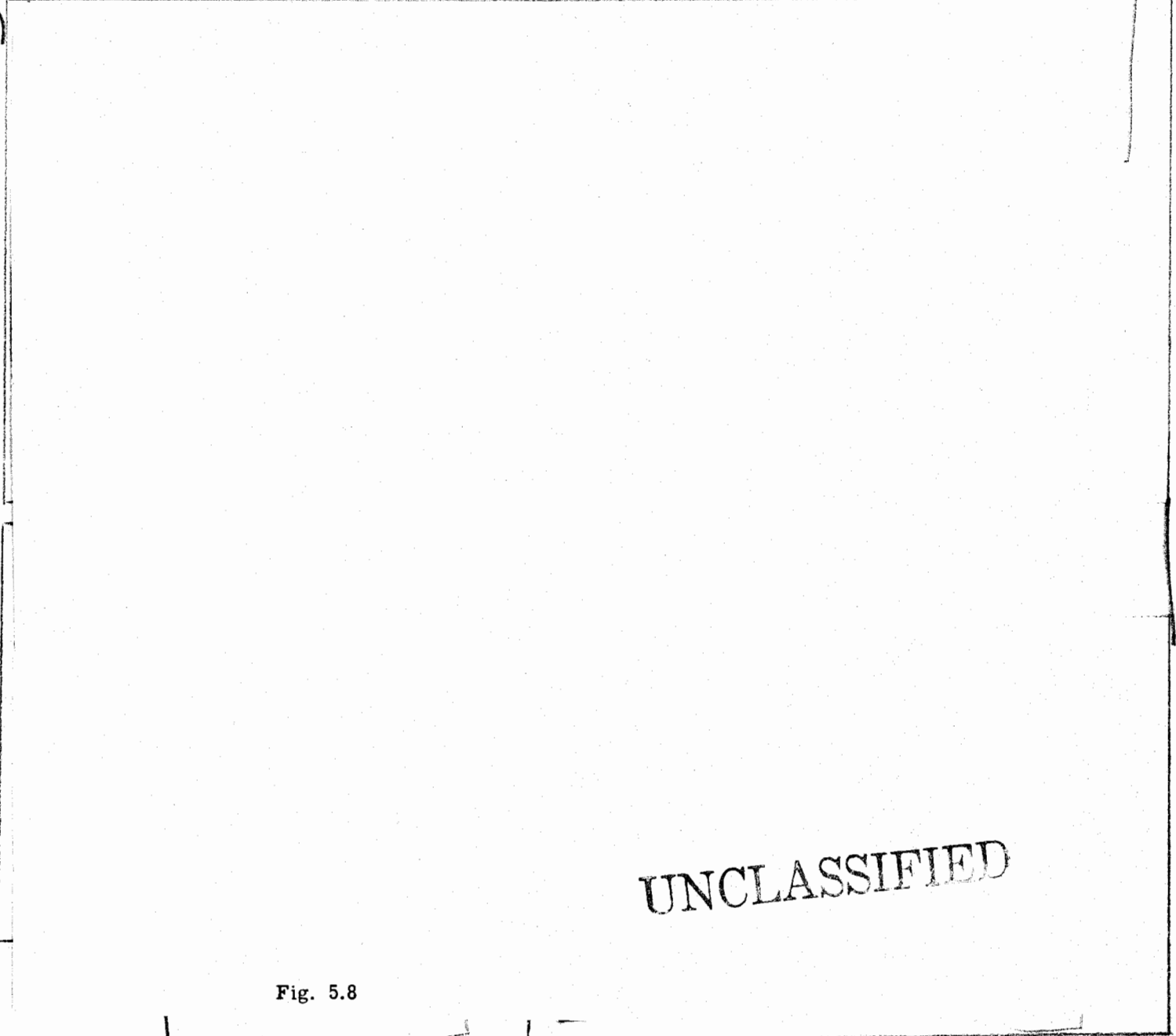

UNCLASSIFIED

Fig. 5.8

~~SECRET~~

~~SECRET~~

b(3)

UNCLASSIFIED

Fig. 5.9

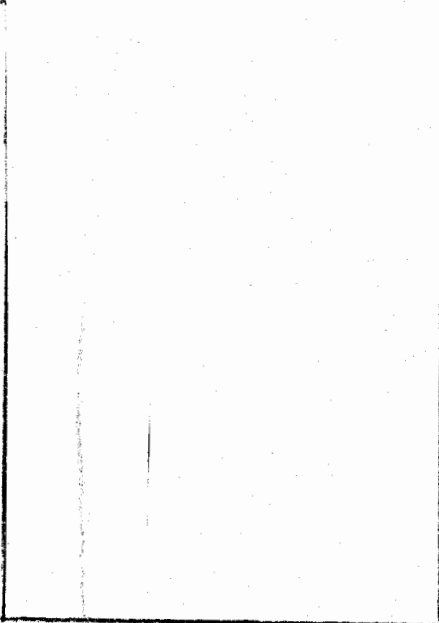

Although the efficacy of the Tom initiator has been proven in several test explosions of complete bombs, a detailed study of some of its characteristics has been made.

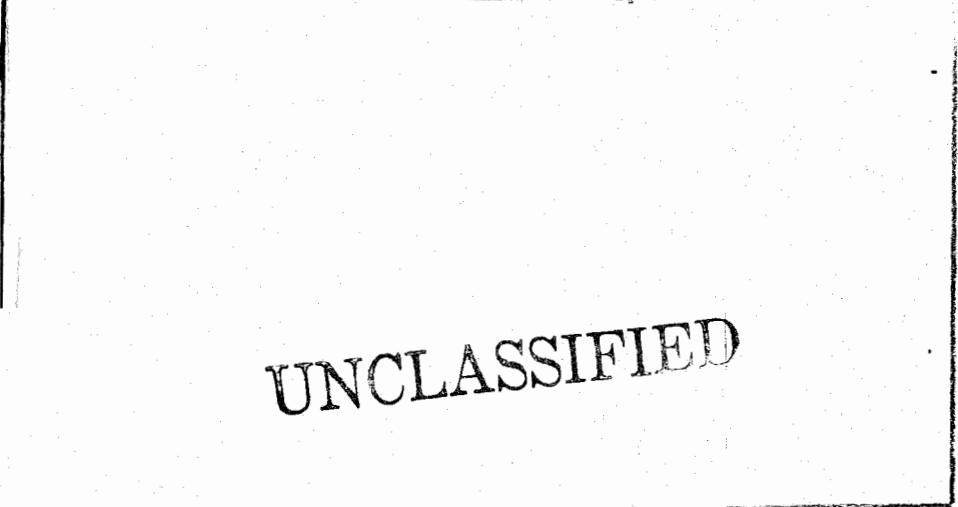

Fig. 5.10

b(3)

b(3)

UNCLASSIFIED

\*The maximum rate of neutron production is 2.8 neutrons/ $\mu$ sec per curie of polonium, for the ( $\alpha$ ,n) reaction with beryllium.

~~SECRET~~

~~SECRET~~

during storage. The purpose of the first is to determine the strength in curies so as to make sure it lies within the acceptable limits. This is done by measuring the intensity of the gamma rays by means of a Geiger, or other, counter.

b(3)

UNCLASSIFIED

Fabrication of Tom Initiators

b(3)

UNCLASSIFIED

~~SECRET~~

~~SECRET~~

b(3)

UNCLASSIFIED

5.5 External Initiators

b(3)

One problem in the use of an externally activated initiator is that of precise timing. For this purpose, it is necessary to know the transit time of the bomb, from the triggering of the X-unit to the time the implosion shock wave reaches the center of the core.

b(3)

UNCLASSIFIED

~~SECRET~~



~~SECRET~~

UNCLASSIFIED

b(3)

The ENS Initiator

The new external initiator, called the ENS (Experimental Neutron Source), makes use of the fact that 14-Mev neutrons are released in the T-D reaction, between tritium and deuterium nuclei. However, the energy required to make the reaction take place is here supplied by accelerating tritium ions (tritons) in an electrical field; these high-energy ions then impinge upon, and react with, deuterium nuclei.

b(3)

Fig. 5.12

UNCLASSIFIED

~~SECRET~~

~~SECRET~~

UNCLASSIFIED

b(3)

The total weight of the present ENS and time-delay unit is just over 100 pounds and its volume is about 2 cu. ft.

b(3)

The neutron yield of the ENS initiator is more than sufficient to meet these requirements.

The reliability of the ENS system has been proved in numerous tests, although it has not yet been used in an actual weapon.\*

b(3)

#### 5.6 Details of Gun-Type Weapons

##### Introduction

As previously indicated, the gun-type bomb was the first nuclear fission weapon considered and was also the first to be used in combat.

UNCLASSIFIED

b(3)

\*A definite development program aimed at the design and production of an externally initiated implosion weapon has been started.

~~SECRET~~

~~SECRET~~

UNCLASSIFIED

b(3)

[redacted] Although the various components

could be treated in turn, as with implosion weapons, it is more convenient, in the present case, to consider each gun-type weapon model as a whole.

Since the LB (Little Boy) bomb is now obsolete, it will be referred to very briefly.

b(3)

The length of the LB was 128 inches, including the 32-inch tail, and its diameter, with its ballistic envelope, was 28 inches; it weighed 8900 pounds, largely due to the very massive steel case.

b(3)

[redacted]

The Mark 8 Weapon

b(3)

[redacted]

This figure also indicates some of the more important dimensional characteristics of the warhead of the bomb.

UNCLASSIFIED

~~SECRET~~

~~SECRET~~

UNCLASSIFIED

b(3)

Fully loaded weapons can be safely stored side by side in any relative positions. In flight, safing is achieved by tapes on the arming mechanism, which interrupt the pyrotechnic chain; these are pulled out before the bomb is dropped.

The Abner Initiator

b(3)

The initiator designed for the Mark 8 weapon is called the Abner, shown in section in

Fig. 5.14.

b(3)

UNCLASSIFIED

The

~~SECRET~~

~~SECRET~~

54.8 inches, and the diameter is 11 inches at the base; the total weight is 805 pounds, and its maximum range is about 26,000 yards.

UNCLASSIFIED

b(3)

The Mark 9 is said to be safe from the nuclear standpoint when immersed in or filled with water and in any position relative to another similar weapon.

b(3)

The temperature limits for storage are set at 110° to -40°F and 110° to -20°F for operation.

The Squab Initiator

b(3)

are used in each weapon for safety.

The initiator employed is called the Squab and two

b(3)

UNCLASSIFIED

~~SECRET~~

~~SECRET~~ b(3)

UNCLASSIFIED

b(3)

Fig. 5.15

In addition to the counting and other inspection tests, the Squab units are radiographed, by means of X-rays. These tests are essentially the same as those applied to the Abner initiator, as described above.

The TX-11 Weapon



b(3)

In addition, it must be capable of external carriage by an aircraft at high speeds. These requirements are achieved by certain mechanical modifications which need not be considered here. The TX-11 bomb will also have an improved fuzing system.

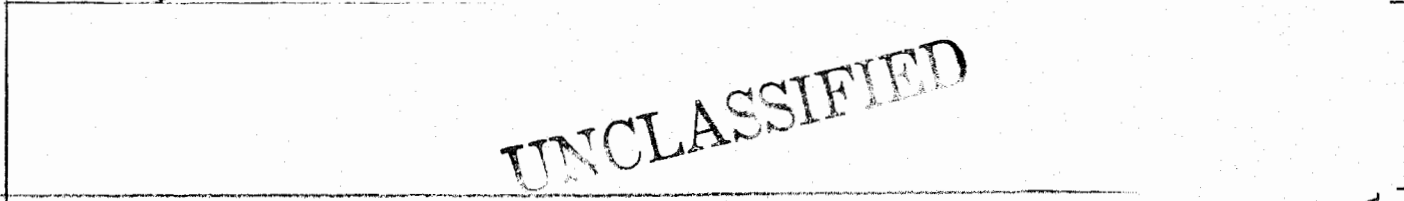

b(3)

UNCLASSIFIED

~~SECRET~~

~~SECRET~~

UNCLASSIFIED

The TX-19 Weapon

The primary requirement of the TX-19 is that it shall be an artillery shell, like the Mark 9, but weighing about 200 pounds less, so that its range may be increased by about 5000 yards.

Table 5.5 Calculated Characteristics of TX-19 Shell with Various Tampers

UNCLASSIFIED

~~SECRET~~

~~SECRET~~

UNCLASSIFIED

b(3)

Fabrication of Gun-Type Weapon Components

The fabrication procedures for the projectile, target, and initiator are much the same as those used for the components of implosion weapons. The oralloy is first cast in vacuum, and then machined to the proper size.

b(3)

5.7 Critical Assembly Measurements

b(3)

Determination of Critical Mass

UNCLASSIFIED

However, these estimates must always be checked by critical measurements of the various partial or complete assemblies.

The approach to criticality is studied by determining the neutron multiplication in a number of subcritical assemblies. Although, by definition, a self-sustaining chain reaction is not possible in a subcritical system, there is nevertheless some neutron multiplication, as may be shown in the following manner. It was seen in Section 1.2 that if  $S$  neutrons are introduced into a fissile system,  $kS$  neutrons will be present after the first generation,  $k^2S$  after the

~~SECRET~~



~~SECRET~~

UNCLASSIFIED

Determination of Alpha

As a measure of the neutron properties of a multiplying system, measurements are made of the multiplication rate,  $\alpha$ , in various materials. However, instead of determining the rate of increase of neutron density with time, the rate of decrease, after fission, is observed. The initial rate is dependent on the same  $\alpha$  as determines the increase of neutron density. Two methods for estimating  $\alpha$  have been used. In the first, less convenient, procedure, which has hitherto been employed in only one experiment, a burst of neutrons is injected by means of a betatron (see Section 5.5) into an assembly that is between delayed and prompt critical. A large number of chains are thus initiated, and the prompt neutron decay rate is determined by means of neutron counters. From this decay rate the value of the (prompt)  $\alpha$  for the given system can be calculated.

The alternative (Rossi) method makes use of a near (delayed) critical assembly, a single neutron being introduced at intervals, either by spontaneous fission or from a suitable source. Each (effective) neutron starts a chain, which soon dies out; then another chain is started and dies out, and so on for the duration of the experiment. Thus, instead of being subjected to the neutrons from a large number of chains almost simultaneously the counters are exposed over an appreciable period to neutrons from a large number of chains one at a time. The method is thus statistical in character.

The neutron counting is carried out by means of a 10-channel delay circuit. The first channel is activated by an initiating pulse corresponding to the entry of a neutron; then, after a pre-determined interval, the second channel is activated for a short time; then, after another interval, the third channel is activated, and so on for intervals ranging from 0.25  $\mu$ sec to a total of a few milliseconds after initiation. From the accumulated counts for the various channels, the time rate of decay of the prompt neutrons after fission can be calculated and  $\alpha$  determined.

The value of  $\alpha$  obtained in this manner, with near delayed critical assemblies, differs from that which applies to the highly supercritical systems in a fission weapon. By finding experimentally how  $\alpha$  varies with the mass of material, it is possible, in principle, to estimate the multiplication rate for supercritical masses. However, such data have not yet been applied in theoretical efficiency and yield calculations.

UNCLASSIFIED

~~SECRET~~

~~SECRET~~

UNCLASSIFIED

The Control Point (C.P.) area is located between Frenchman and Yucca Flats near the Yucca (dry) Lake. Here are a number of structures, including the control building where timing and firing signals originate. This building also houses the office of the test director and his staff, the weather service, and various scientific, electronic, and machine shop facilities. The Rad-Safe section, which is responsible for radiological safety operations, including personnel monitoring and decontamination, occupies another building in the C.P. area.

Associated with each of the target areas are a number of concrete shelters, usually underground and covered with protective mounds, for various instruments required to study the phenomena accompanying the nuclear explosions. These shelters are built to withstand shock and to protect the instruments from damage and film from radiation exposure; hence, they are of a relatively permanent character. The distance of the instrument shelter from the zero point is determined by the needs of the particular measurement to be made; it usually represents a compromise between the increased cost of long cables if the distance is large and of the heavier structure required if the distance is short. The instrument shelters are provided with power supply, cables to the target area zero point, timing signals, and various other facilities. Most of the equipment is activated by remote control, utilizing relays energized by signals from the central timing system.

The local headquarters for several organizations connected with NPG activities are at Mercury, Nevada, just outside the southern boundary of the Proving Grounds proper. Various administrative offices are located there, and offices and laboratory facilities are available for experimental groups in some thirty quonset huts. Living quarters are provided at Mercury for civilian and military personnel engaged in the test operations. Military personnel receiving tactical orientation are quartered at Camp Desert Rock, about three miles southwest of Mercury.

#### Pacific Proving Grounds

The Pacific Proving Grounds include the Eniwetok (Fig. 6.2) and Bikini Atolls (Fig. 6.3); although the latter has not been used since Operation Crossroads in 1946, new facilities are being installed for the Castle tests in 1954. The two atolls are about 180 miles apart, and communication between them is maintained by air, sea, telephone, and radio. These atolls, which are from 13 to 25 miles across, consist of more or less circular groups of small coral islands, covered to varying depths with coral sand. As a general rule, the individual islets are connected by a coral reef, although much of this may be submerged even at low tide. There are, however, gaps in the reef through which ships may enter the lagoon.

The test operations at the Pacific Proving Grounds are performed by a task force composed of scientific and military personnel whose headquarters are located on Parry Island or aboard ship. Living accommodation is provided on Eniwetok and Parry Islands, although during

~~SECRET~~

UNCLASSIFIED

~~SECRET~~

UNCLASSIFIED

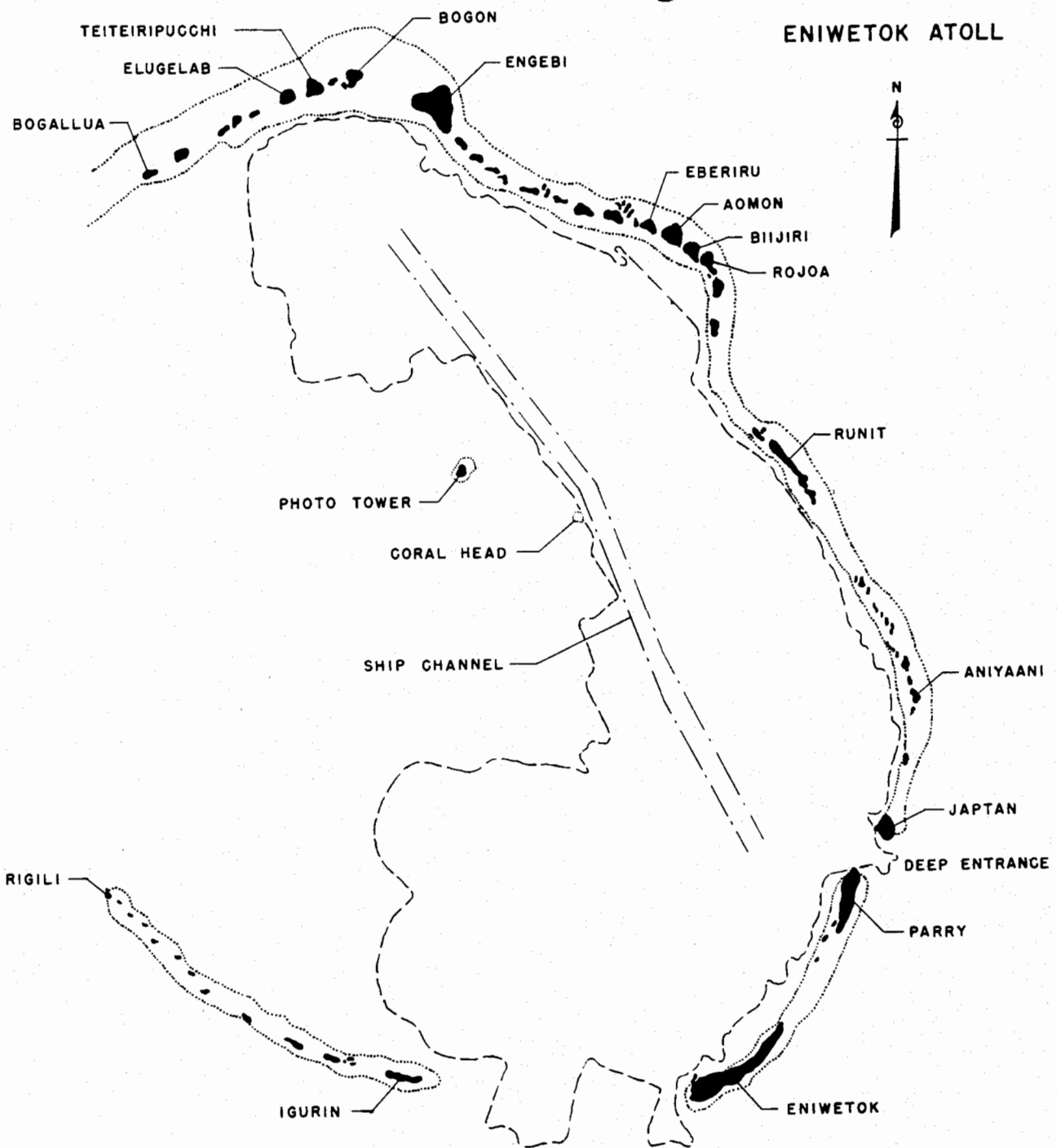

Fig. 6.2

UNCLASSIFIED

~~SECRET~~

~~SECRET~~

UNCLASSIFIED

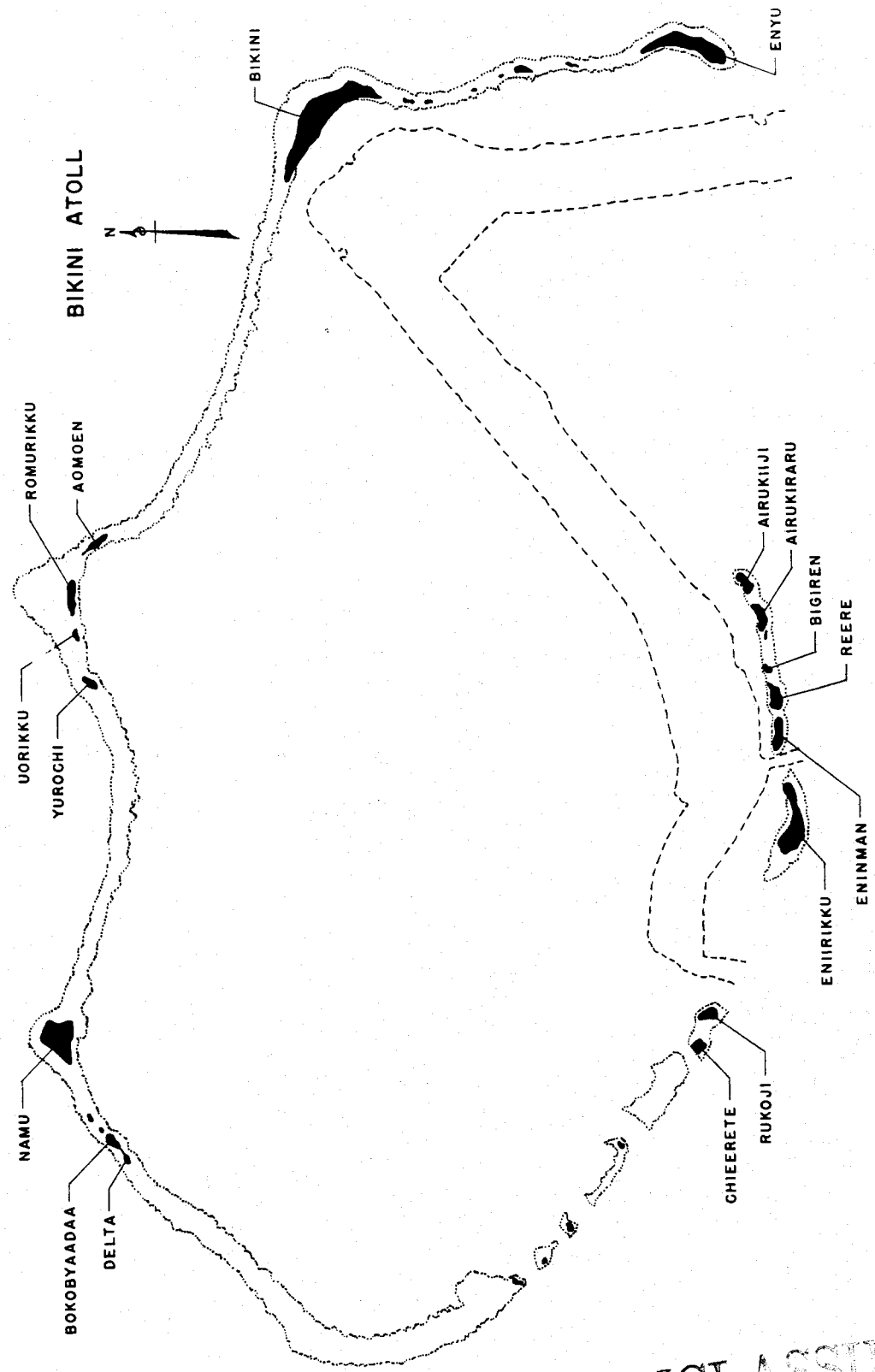

Fig. 6.3

UNCLASSIFIED

~~SECRET~~

~~SECRET~~

UNCLASSIFIED

an operation some personnel may spend most of their time in temporary camps on other islands where tests are being made.

Different islands are selected as target areas, according to circumstances. For example, Engebi, Aomon, and Runit were used for Sandstone; Engebi, Eberiru, and Runit for Greenhouse; and Elugelab and Runit for Ivy. In Castle it is planned to detonate some test devices over water in the lagoon. Instruments are located in shelters, similar to those at NPG; these may be on the target island itself or on an adjacent island. In addition, photo-towers for cameras are spread throughout the atoll. At Eniwetok the timing and firing signals originate from Parry Island, and at Bikini from Enyu Island. The signals are transmitted by cable or by radio according to circumstances, partly determined by distance and the importance of the experiments.

Because of the climatic and other conditions at the Pacific Proving Grounds, instrument shelters are primarily designed for use in a single test. Nevertheless, they may serve for several tests if they are in operative condition. In general, the facilities available are similar to those outlined above for the Nevada Proving Grounds.

6.3 Nuclear Explosion Phenomena

The Ball of Fire

In order to understand the significance of some of the measurements made in the course of weapons tests, it is desirable to review briefly certain phenomena associated with a nuclear explosion. After the initial stages of radiation flow and its cessation, when the temperatures are much higher, the bomb material will be at a more or less uniform temperature of about 1,000,000°K, i. e., 0.08 keV. In this condition there is a considerable emission of energy as electromagnetic radiations covering a wide range of wave lengths, from infrared (thermal) or longer, through the visible to the ultraviolet and beyond. Much of this radiation is absorbed by the air immediately surrounding the bomb, with the result that the air itself becomes heated to incandescence. In this condition, the detonated bomb begins to appear, after a few microseconds, as a luminous ball of fire.

As the ball of fire grows, and its temperature falls to about 300,000°K, at about 0.1 to 1 millisecond after detonation, a shock wave develops. At first, the shock front coincides with the radiation front, but as the temperature falls, the (luminous) shock wave moves ahead of the radiation. The reasons why the shock front travels more rapidly than radiation under these conditions is somewhat as follows:

In a vacuum radiation photons travel with the speed of light, but as the high energy photons move forward into the air, they are likely to be captured by the molecules (or atoms) present. The resulting excited molecules (or atoms) retain their excess energy for a time and

~~SECRET~~

UNCLASSIFIED

UNCLASSIFIED

SECRET

then emit it as another photon of the same, or slightly different, energy. If the mean free path, i. e., the distance between successive captures, of a high-energy photon is taken to be 0.01 cm, and the life of the excited molecule is  $10^{-8}$  sec, then the effective speed of the photon is about  $10^6$  cm per sec. But since the emitted photon moves off in a random direction, the rate of forward motion, i. e., in the direction the radiation is propagated, will be considerably less. In fact, it will be less than the velocity of the shock front at the high temperatures and pressures existing in the ball of fire.

Since the shock front is luminous, the diameter of the ball of fire, as seen by the (protected) eye or by a camera, is determined by the motion of the shock wave. The lagging radiation front is not seen because of the high luminosity of the surface of the ball of fire. As the shock wave expands, the ball of fire is observed to grow rapidly in size for about 20 to 100, or so, millisecc, depending on the yield of the bomb. At the same time, the surface temperature continues to fall, and when it reaches about  $2000^{\circ}\text{K}$ , the shock front is no longer luminous.

From roughly this point on, the apparent size of the ball of fire is determined by the radiation front which may now be visible, or by air heated by shock passage. The rate of increase of diameter with time is less than before, since the radiation front still advances more slowly than the shock front. Hence, the invisible shock front continues to travel ahead rapidly; after 1 sec it may be some 600 yards beyond the ball of fire and after 10 sec it may have advanced two miles or more.

The point at which the (invisible) shock front moves ahead of the (visible) ball of fire is called the "breakaway." [As stated above, the surface temperature of the ball of fire is then about  $2000^{\circ}\text{K}$ .] However, the temperature of the radiation front is considerably higher, and as this begins to replace the rapidly cooling and advancing shock front, the surface temperature of the ball of fire apparently increases once again. This effect may be enhanced by a decrease in the opacity of the air. The apparent surface temperature thus rises until the temperature of the hot core, i. e., about  $7000^{\circ}\text{K}$ , is attained, and it then falls steadily due to cooling of the gases by radiation and by expansion.

The variation of the surface temperature (T) of the ball of fire and its apparent radius (R) after the nuclear explosion, is indicated in Fig. 6.4, in which both scales are logarithmic. The breakaway point corresponds to the first minimum in the temperature curve, after which the surface temperature rises, as stated above. It is seen, from the marked change in direction of the R curve, that the ball of fire grows at a much less rapid rate after the breakaway point. The luminosity (or radiation flux per unit area) of the ball of fire depends on the

\*Times and temperatures given in this and the succeeding paragraphs vary with the yield of the weapon. They are particularly applicable, however, to weapons with yields in the range from about 10 to 100 kt.

UNCLASSIFIED

SECRET

~~SECRET~~

UNCLASSIFIED

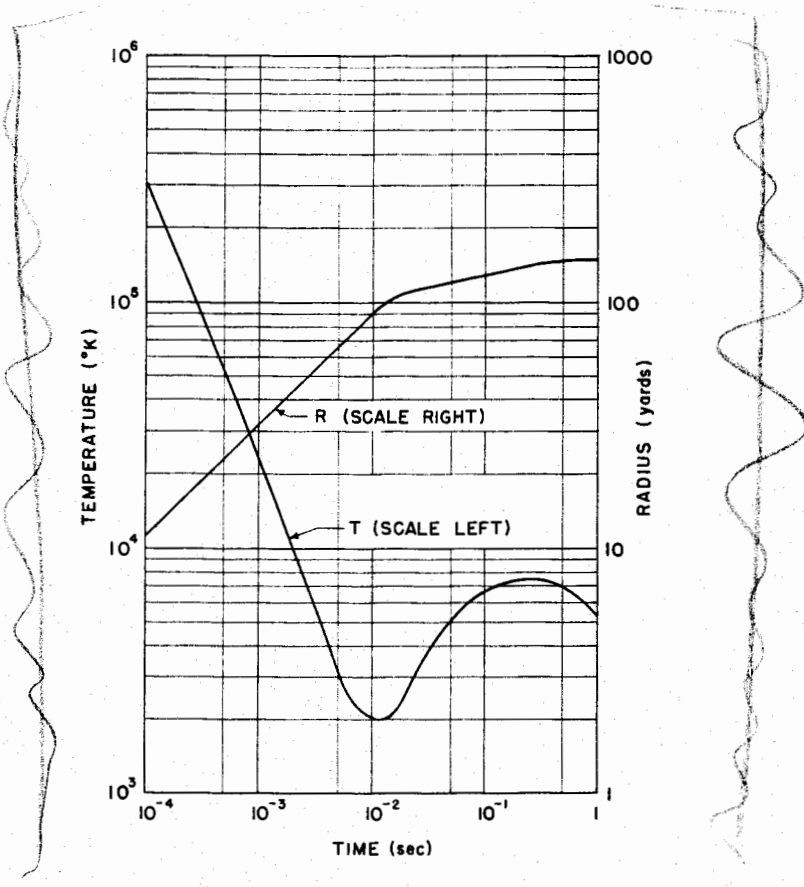

Fig. 6.4

Surface temperature, being roughly proportional to  $T^4$ , at a given distance. It follows, therefore, that after the explosion the luminosity will first decrease to a minimum at the breakaway, increase to a maximum, and then gradually fall off to zero in the course of time.

It may be mentioned that various oxides of nitrogen are formed in the air surrounding the ball of fire and they have some influence on its luminosity. Above 5000°K these oxides are almost completely dissociated into atoms, but below this temperature some nitrogen dioxide, which is a brown gas, is formed. This undoubtedly contributes to the decrease in luminosity just before the breakaway. Molecules of gaseous nitrous acid have a similar effect.

At least for as long as the ball of fire is visible, it emits what is generally called prompt or effective thermal radiation, although it covers a considerable range of wave lengths. After traveling an appreciable distance in air, however, almost all radiations of wave lengths less about 3000 Å are absorbed. The proportion of the bomb energy liberated in the form of effective or prompt thermal radiation varies with the yield, as will be seen later.

~~SECRET~~

UNCLASSIFIED

~~SECRET~~

UNCLASSIFIED

### Atomic Cloud and Fall-out

When the ball of fire has cooled appreciably, the vapors of fission products and other bomb residues condense to form a smoke made up of small solid particles having a range of sizes. This, together with any dirt or sand that may have been sucked up from the earth's surface, ultimately forms the atomic cloud. The rate of ascent of the cloud column depends upon the meteorological conditions. At first it climbs rapidly, reaching an altitude of 10,000 ft in less than a minute, but later it slows down, so that the maximum height, of about 40,000 to 60,000 feet, may be attained in 10 minutes or so. The actual times and heights are determined by the energy release of the bomb as well as by the atmospheric conditions, but the values quoted may be taken as more or less typical.

Upon entering a region where the density of the atomic cloud is the same as that of the surrounding air, e.g., when the base of the stratosphere is reached, where the temperature of the atmosphere is almost constant and there is practically no motion due to convection, the cloud will spread out for a distance of several miles and form the characteristic mushroom shape. This is ultimately dispersed by winds into the surrounding atmosphere. If, in its ascent, the atomic cloud column should pass through a temperature inversion layer, it will tend to "mushroom" out horizontally to a small extent, but the main movement will still be upward, until the conditions are suitable for the extensive spreading just described.

When the cloud particles, which consist chiefly of highly radioactive oxides of fission products, uranium, etc., collide with particles of dirt they generally adhere. The resulting radioactive particles gradually fall back to earth, giving rise to the phenomenon known as "fall-out." The extent and nature of the fall-out depend on various circumstances associated with the height at which the nuclear device was detonated, the nature of the terrain, and the meteorological conditions. The importance of the fall-out lies in the fact that it may constitute a radiological hazard.

### Gamma Radiation

Although gamma-ray emission accompanies the actual fission process, it is probable that this particular radiation is largely absorbed in the heavy bomb material, so that only a very small proportion escapes. However, within a very short time, usually a fraction of a microsecond, depending on the bomb model, gamma rays are produced by indirect or secondary processes. The two most important are due to the neutrons liberated in fission. First, there are the  $(n,\gamma)$  or radiative capture reactions, in which neutrons are captured by nuclei present in the bomb residues, followed by the emission of gamma rays. In addition, elastic scattering of fast fission neutrons by heavy, e.g., uranium, nuclei also results in the production of high-energy gamma radiation. It is these secondary radiations which constitute almost the whole of what is called the "prompt" gamma rays associated with a nuclear explosion.

UNCLASSIFIED

~~SECRET~~



UNCLASSIFIED

~~SECRET~~

The gamma rays liberated after the first few microseconds are referred to as "delayed" gamma rays. These radiations may be divided into two categories. Up to about 0.3 sec after the explosion, the delayed gamma rays are due mainly to  $(n,\gamma)$  captures by nitrogen of the air. The gamma rays produced in this manner have high energies, chiefly in the range from 5 to 8 Mev; at distances greater than 2,000 yards from the explosion they may make the major contribution to the gamma radiation received from a fission weapon.

The second category of delayed gamma rays is made up of radiations of lower energy (2 to 3 Mev) emitted in the radioactive decay of the fission products, especially those of short life, present in the ball of fire and in the atomic cloud. Although the delayed gamma radiation is actually formed, with decreasing intensity, over a long period of time, it is generally assumed, for practical purposes, that the emission lasts for a minute or so. In the first place, the fission products of very short life, which make the major contribution to the gamma radiation immediately after the explosion, will have decayed almost completely in this time. Further, by the end of a minute, or less, the radioactive cloud will have attained a height of some 2 miles, as indicated above, so that the delayed gamma radiation is attenuated to negligible proportions before it reaches the ground. The transmission of gamma radiation from the fission products is strongly affected by the hydrodynamics of the shock wave which removes a large proportion of the air between the bomb and detecting instruments on the ground.

#### Emission of Neutrons

The great majority of the neutrons liberated in a nuclear explosion are the prompt neutrons emitted simultaneously (or almost simultaneously) with the fission process itself. There are, in addition, the delayed neutrons, constituting less than 1 per cent of the total (Section 1.2), but these are of little significance in the present connection. However, even though the neutrons which succeed in leaving the detonated bomb originate as prompt neutrons, there is some delay in reaching the earth's surface.

It was seen above that some of the fission neutrons are captured in the bomb material and others undergo inelastic collisions and thereby have their energy decreased, i. e., they are slowed down. A few fast neutrons succeed in escaping, but the others are slowed down to some extent by elastic collisions with the light elements present in the HE system. The (relatively) slow neutrons are temporarily trapped here, but as the shock wave moves outward from the core, the material is dispersed and the neutrons escape into the surrounding air. The transport of the slow neutrons through space is thus strongly affected by the shock wave. In their diffusion through the atmosphere, some of the neutrons are slowed down still further and may then be captured by nitrogen nuclei.

Because of the various possible scattering processes which they may undergo, the neutrons

~~SECRET~~

UNCLASSIFIED

~~SECRET~~

reaching a detecting instrument on the ground will cover a large range of energies. The distribution of the neutrons in this manner is referred to as the neutron spectrum. ~~Those~~ neutrons which have not been scattered have high energies, e.g., 3 Mev or more; others have energies in the intermediate range, while the great majority are slow neutrons. However, because of capture by nitrogen nuclei, very few have energies below about 0.2 ev.]

b(3)



The proportion of neutrons produced in fission with energies as high as 14 Mev is very small, but if the D-T reaction is involved, a considerable number of neutrons of this energy will be detected.

#### 6.4 Diagnostic Tests

##### Determination of Transit Time

A very great variety of measurements are usually made for each test shot, many of which depend upon the particular information required. However, for essentially all fission weapons the so-called standard diagnostic tests are made; these are the determination of the over-all transit time, the multiplication rate ( $\alpha$ ), and the energy yield of the device. Although yield measurements are always made, determinations of transit time and  $\alpha$  are sometimes omitted. Apart from providing useful practical information, the results of the diagnostic tests serve to check theoretical estimates and to supply data upon which further calculations may be based.

For the measurement of the over-all transit time, i.e., from the instant of firing the detonators to the explosion time, two general methods have been used. In the case of a tower shot, a signal is sent over a coaxial cable to a distant cathode ray oscilloscope when the X-unit is fired. The first gamma rays to appear outside the bomb are picked up by a scintillation detector and a second signal is transmitted by cable to the oscilloscope. After making allowance for the difference in lengths of the cables and the time taken for the gamma rays to reach the detector, the transit time of the bomb can be determined from the separation of the two signals.

The procedure described above, which requires cable connections to the X-unit, cannot be used for an airdrop, and in this event the remote method is employed. A radio transmitter, operating at low power, e.g., about 20 watts, is attached to the bomb case. When the X-unit is fired, the output is instantaneously raised to several hundred watts, so that the signal can be detected at a distance and recorded on an oscilloscope. This continues until the intense ionization of the atmosphere, referred to as the "ion curtain," in the vicinity of the bomb, due to the gamma radiation, prevents further propagation of the radio signal. The level at which

~~SECRET~~

this transmission is cut off is not known exactly, but it is believed to be at about the 30th generation, or so. Allowance for this delay is made in estimating the transit time from the duration of the radio signal. If the generation time is relatively long, e.g., for low values of  $\alpha$  (Section 1.4), this correction may involve an appreciable error.

#### Determination of Alpha

Until recently, only one satisfactory method was available for determining the multiplication rate,  $\alpha$ ; it was based on a measurement of the time-dependence of the prompt gamma rays over a period of about 1  $\mu$ sec. It can be seen from equation (1.16) that  $\alpha$  can be determined if the neutron density,  $n$ , in the exploding bomb is known as a function of time. As seen above, the prompt gamma rays are produced, almost entirely, by the action of neutrons within the bomb. Hence, the prompt gamma-ray intensity, fairly close to the bomb, may be taken as being proportional to the neutron density. Consequently,  $\alpha$  can be readily calculated from the variation of the prompt gamma rays with time.

Originally large (Rossi-type) ion-chambers, having a fast response, were used to detect the gamma rays, but these have now been replaced by scintillation detectors. The latter are located near the bomb, in the case of a tower shot, and long coaxial cables connect them to the horizontal plates of an oscilloscope. A constant, high-frequency sinusoidal signal applied to the vertical plate supplies a timing record. The oscilloscope trace is photographed and then analyzed to give the time dependence of the prompt gamma-ray intensity. By the use of additional cable, the gamma-ray signal is delayed, so that an intensifier pulse to the oscilloscope can build up and thus permit the trace to be photographed.

In order to cover the large range of intensity, several scintillation detectors may be placed at various distances from the bomb. A common timing system is sometimes used for all the oscilloscopes to which they are connected. The detectors nearest to the explosion record the lower intensities of gamma radiation, whereas those which are more remote indicate the higher intensities. Proper allowance is made, of course, for the attenuation with distance.

For an airdrop the scintillation detectors cannot be placed near the bomb. Consequently, they are located on the ground at known distances from the assumed detonation point. Because of the absorption of the radiation, the intensities at the detectors are relatively small and for high bursts amplifiers may have to be used.

b(3)

Another procedure for obtaining  $\alpha$ , which avoids destruction of the detectors, etc., and can be used either for tower shots or airdrops, was first tried out at Operation Sandstone, but did not reach a satisfactory state of development until the Upshot-Knothole test in 1953. One

of its great advantages is that measurements can be made at a distance of 10 miles or so, where the instruments are under direct control, and no coaxial cables are necessary.

When the prompt gamma rays are degraded in energy and absorbed by the air around the bomb, they produce a luminosity, called the Teller light. The intensity of this light is proportional to that of the prompt gamma rays and, consequently, to the neutron density.

b(3)

It is essential that the only light measured should be that coming directly from the bomb to the observer.

In one arrangement for recording the luminosity at very low levels, without the necessity of amplification of signals, the Teller light from the bomb is reflected by a mirror system (Fig. 6.5) and falls on the photomultiplier tube. This is placed as close as possible to the deflecting plates of a cathode-ray oscilloscope tube in a light-tight box. The timing and delay circuits are analogous to those used in the method already described. To provide a wide field of view, the mirrors are in duplicate; consequently, a moderate change in the expected position of the exploding bomb will not affect observation of the Teller light.

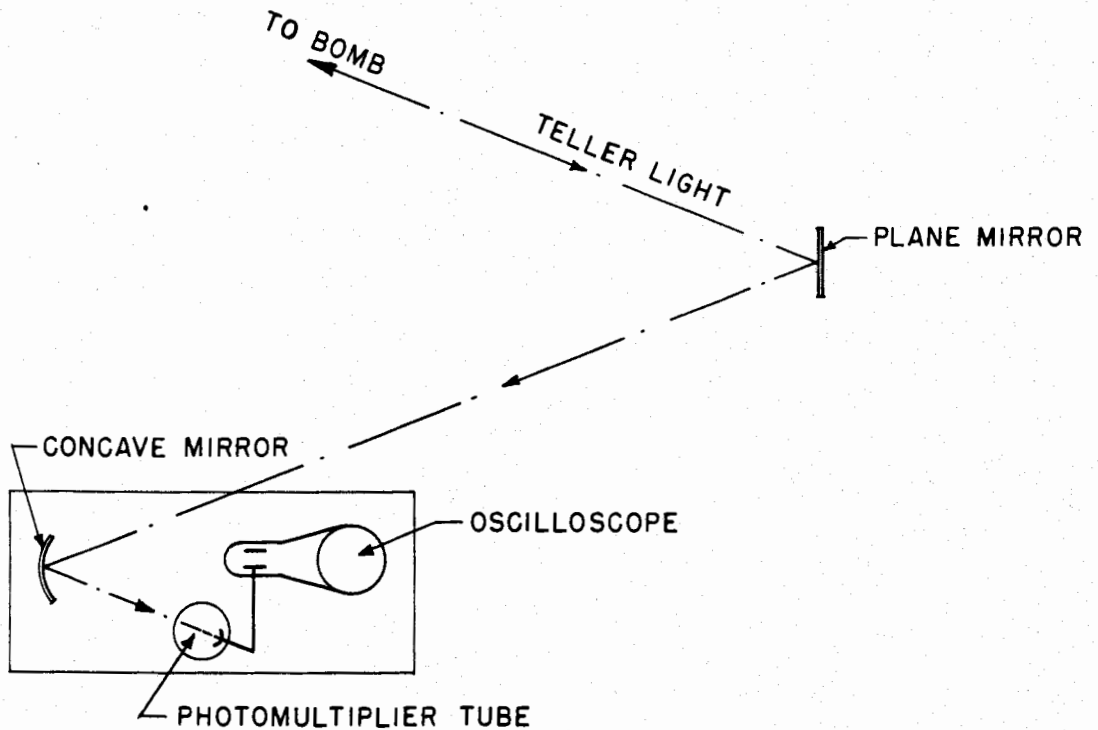

Fig. 6.5

determine the number of fissions that have occurred in the sample. Let

- f = number of fissions corresponding to sample analyzed
- $\theta$  = fraction of bomb in sample analyzed,

then

$$f = \theta F, \tag{6.2}$$

and, upon combining equations (6.1) and (6.2),

$$\phi = \frac{f}{\theta(U + P)}. \tag{6.3}^*$$

Since  $U + P$  may be regarded as known, the determination of the efficiency and yield of a nuclear explosion is reduced to the estimation of  $f$  and  $\theta$  for a given post-shot sample (or samples).

The measurement of  $f$  involves the chemical separation of a particular fission product from the sample of bomb residues and the determination of the amount present by means of its radioactivity. The measured activity of the specified fission product is corrected for decay during the time which has elapsed since the nuclear explosion and for possible losses in the chemical separation; if  $A$  is the resulting corrected activity, expressed as the rate of particle emission, then it can be shown that

$$A = \epsilon \lambda y f, \tag{6.4}$$

where

- $\epsilon$  = counter efficiency, i. e., fraction of particles emitted which are actually counted
- $\lambda$  = radioactive decay constant of the fission product
- $y$  = yield of the given product in fission.

Although  $\lambda$  and  $y$  are known, with moderate accuracy, and  $\epsilon$  can be measured, it is more convenient to combine  $\epsilon \lambda y$  into a single factor. This can be determined by subjecting a small quantity of uranium-235 or plutonium-239 to the action of neutrons, of known density, so that the number of fissions induced can be calculated. Thus,  $f$  for a given sample is known. The specified fission product is then separated chemically and counted, so that the activity,  $A$ , is measured. Then, from equation (6.4), the corresponding value of  $\epsilon \lambda y$ , for the particular counter, fission product, and fissile material, can be obtained.

\*The symbols used throughout this section are those commonly found in J-Division reports, with two exceptions: the efficiency is represented here by  $\phi$ , as is customary in other LASL reports, and  $\theta$  is employed for the fraction of bomb in the sample. The J-Division symbols are  $E$  and  $\phi$ , respectively.

The fission products which have been used most extensively in efficiency measurements are molybdenum-99 (half life 67 hours) and zirconium-97 (half life 17 hours). These isotopes have convenient half lives, and their fission yields, which are among the largest, are not greatly dependent upon the energy of the neutrons causing fission. The  $\lambda\gamma$  values for molybdenum-99 are almost identical for fission of uranium-235 and plutonium-239, so that no correction is necessary if the bomb core contains both of these fissile species. For this and other reasons, molybdenum is the preferred isotope. For zirconium, the  $\lambda\gamma$ 's are slightly different and the value used to determine  $f$  depends upon the composition of the core.

The fraction  $\theta$  of the bomb in the post-shot sample can be determined by analyzing for one of the major constituents, e.g., uranium-235, plutonium-239, or total uranium, and correcting for the amounts lost in nonfission reactions, such as  $(n,\gamma)$ ,  $(n,2n)$ , etc. Since the total amount of each of these species present in the original bomb is known, the fraction of the bomb in the sample can be calculated.

Another method for determining the fraction of the bomb in the post-shot sample makes use of a different principle. A radioactive tracer, in known amount, is included in the bomb before detonation. If the quantity present in the post-shot sample is then measured, the fraction of the bomb in the sample can be calculated. The supposition is here, of course, that the tracer is uniformly distributed throughout the whole of the bomb residues, and this may not be the case. Measurements of this kind have been made with polonium-210 as tracer, but with indifferent success. Nevertheless, it is proposed to make further determinations with this isotope and also with curium-242 as tracer.

#### Determination of Fraction of Fissions in U-235, Pu-239, and U-238

It is of interest to know what proportion of fissions has occurred in uranium-235, plutonium-239, and uranium-238, respectively. Radiochemical methods have been developed for this purpose, although they are not too accurate. The fraction of the total fissions involving uranium-235 is represented by  $a$ , the fraction in plutonium-239 by  $b$ , and that in uranium-238 by  $c$ , so that

$$a + b + c = 1. \quad (6.5)$$

Hence, if any two of  $a$ ,  $b$ ,  $c$  are determined, the third is known.

The value of  $c$  can be obtained by utilizing the experimental fact that the ratio of the cross section for the  $U^{238}(n,2n)U^{237}$  reaction to that for the fission of uranium-238 is roughly constant, independent of neutron attenuation in the uranium. Hence, if the amount of uranium-237 in the bomb residue sample is measured, by means of its radioactivity, the number of uranium-238 nuclei which have undergone fission, and hence,  $c$ , can be calculated.

~~SECRET~~

UNCLASSIFIED

The determination of a and b is possible, in principle, if there are available two fission products which have very different yields (or activities) for the fission of uranium-235, plutonium-239, and uranium-238. Let

$R_{25}$  = ratio of activities for U-235 fission

$R_{49}$  = ratio of activities for Pu-239 fission

$R_{28}$  = ratio of activities for U-238 fission,

so that the observed activity ratio, R, is given by

$$R = aR_{25} + bR_{49} + cR_{28}. \tag{6.6}$$

Since  $a + b + c = 1$ , then, if the three activity ratios,  $R_{25}$ ,  $R_{49}$ , and  $R_{28}$ , have been determined, any two of the fractions a, b, c, can be calculated provided the third is known. For weapons containing only uranium-235 or plutonium-239 as the fissile material, the problem is, of course, simplified.

Of the pairs of isotopes that may be used in the foregoing connection, one is always chosen to be molybdenum-99; the other may be silver-111, palladium-112, cadmium-115, or cerium-136. Although the method is sound, in principle, it has not yet given satisfactory results. This is believed to be due to a partial separation (or fractionation) of the elements present in the fission products. Consequently, the post-shot samples do not always have the same composition as the bomb residue as a whole. Such is not the case for molybdenum-99, and that is one reason why this isotope is much used in yield determinations.

Provided c is known, a and b can be calculated if the measured ratio of uranium-235 to plutonium-239 in the post-shot sample is compared with the known ratio in the original bomb. This method involves corrections for the amounts of these two isotopes lost in nonfission reactions, as well as for the formation of plutonium-239 as a result of neutron capture by uranium-238, followed by two stages of beta decay.

In a test shot the fraction a can be measured by incorporating into the or alloy an indicator, such as titanium, thorium, thallium, or tungsten. The titanium and thorium react with fast neutrons, i. e.,  $Ti^{47}(n,p) Sc^{47}$  and  $Th^{232}(n,2n) Th^{231}$ , respectively, whereas the thallium and tungsten capture slow neutrons, i. e.,  $Tl^{203}(n,\gamma) Tl^{204}$  and  $W^{186}(n,\gamma) W^{187}$  followed by  $W^{187}(n,\gamma) W^{188}$ , to form characteristic, identifiable products. By assuming that the uranium-235 and the indicated isotope have been subjected to the same neutron flux, it is possible, from a determination of the product formed and the known cross section of the reaction, to calculate the number of uranium-235 nuclei which have undergone fission.

~~SECRET~~

UNCLASSIFIED

Somewhat analogous procedures can be used to determine b, except that, as in the method described above for c, the indicator or detector species is already present. In addition to undergoing fission, plutonium-239 is involved in the reaction  $\text{Pu}^{239} (n, \gamma) \text{Pu}^{240}$ . Consequently, if the amount of plutonium-240 present in a post-shot sample is determined, and allowance made for the proportion in the original plutonium and the amount lost in various neutron reactions, the number of plutonium-239 fissions can be calculated. It is of interest to note that the plutonium-240 is determined with a mass spectrograph rather than by its radioactivity. The alpha particles from the 240-isotope are not easily distinguished from those emitted by plutonium-239 because of their similar energies.

Another reaction for determining b is  $\text{Pu}^{239} (n, 2n) \text{Pu}^{238}$  with fast neutrons. In this case, the amount of plutonium-238 in the bomb residue sample can be estimated from its alpha radioactivity since the particles can be resolved from those emitted by the other plutonium isotopes.

The plutonium used in weapons invariably contains some plutonium-241 as an impurity; this is a beta-particle emitter with a half life of 14 years, the decay product being americium-241, half life 470 years. It is seen, therefore, that the plutonium components of bomb cores which have been stored for some time will contain appreciable amounts of americium-241. In the exploding bomb, the latter will undergo the reaction  $\text{Am}^{241} (n, \gamma) \text{Am}^{242}$ , followed by beta decay of the americium-242 to form curium-242. The curium-americium ratio in the post-shot sample will thus be roughly proportional to the amount of fission which has occurred in the plutonium-239.

### Sample Collection

The collection of representative samples for radiochemical analysis after a nuclear explosion has proved to be quite a difficult matter. For reasons not clearly understood, fractionation occurs in the highly complex system, so that a particular portion of the bomb residue may not have the same composition as the average of the whole. In addition to the requirement that the post-shot sample shall be representative, it must be of sufficient size to make accurate analysis possible; it must not be contaminated during collection, and it must be capable of relatively rapid recovery and delivery to the laboratory.

Various methods of sample collection have been tried out at one time or another; the most satisfactory results have been obtained either by the use of drone aircraft guided through the atomic cloud after an explosion or by means of manned aircraft flying into the cloud. The samples collected are of two types: "snap" samples in which a container is filled with essentially gaseous material, and particulate samples obtained by drawing the air and other gases through a filter. The mission of the manned aircraft is planned so as to give satisfactory samples with minimum radiation exposure of the crew.



same in both cases, and appropriate corrections must be made for any differences.

According to the theory of strong shocks, the rate of propagation of the shock front and, hence, in the present case, the rate of increase in the radius or diameter,  $D$ , of the ball of fire, is given by

$$D = kt^n, \quad (6.8)$$

where  $k$ , for a particular bomb, is a constant related to the yield,\* and the exponent  $n$  is dependent upon  $\gamma$ , the ratio of the specific heats of the material at the shock front. When  $\gamma$  is 1.4, the value of  $n$  is close to 0.4, and then equation (6.8) can be written as

$$D = kt^{0.4} \quad (6.9)$$

It appears that  $k$  is roughly proportional to  $Y^{1/5}$ , so that a good approximation when  $n$  is 0.4, has been found to be

$$Y = C \rho_o k^5 = C \rho_o \frac{D^5}{t^2}, \quad (6.10)$$

where  $C$  is a constant determined from observations on the balls of fire produced by bombs of known yield;  $\rho_o$  is the density of the ambient air.

To use equation (6.10) for the determination of yields, the data for  $D$  at various times  $t$ , obtained from the Rapatronic camera films, are plotted and the point found at which  $n$  in equation (6.8) is 0.4. Upon substituting the corresponding values of  $D$  and  $t$  into equation (6.10), the yield can be calculated.

Recently a new, absolute (analytic) method for obtaining yields, independent of scaling principles or knowledge of yield of other bombs, has been developed. It permits the calculation of the total energy produced in the nuclear explosion at any time up to breakaway, using hydrodynamic and thermodynamic principles. According to this method, which takes into account such factors as the transport of radiation in the early stages of the development of the shock front, the large mass of the bomb, and time variations in the equation of state of air and in the ratio of the specific heats at the shock front, the yield may be represented by

$$Y = \frac{F}{32} \rho_o n^2 \frac{D^5}{t^2} \quad (6.11)$$

\*The factor  $k$  is generally represented by  $\phi$ , but this symbol is used here for the efficiency.

~~SECRET~~

UNCLASSIFIED

$$\lambda = \text{mean free path of gamma radiation}$$

$$= 370 \times \frac{1.12 \times 10^{-3}}{\rho}$$

$$\rho = \text{density of air in g/cm}^3.$$

At a specified distance from the explosion, the radiation dosage is seen to be roughly proportional to the yield, for a given density of air.

Neutron Measurements

Neutron measurements have been made at test shots for a variety of purposes. Among these may be mentioned the following: energy spectrum of neutrons, neutron flux as function of time, and total number of neutrons arriving at different distances from the explosion. In addition, neutron measurements have been found particularly useful for the study of thermonuclear processes.

The neutron spectrum from a nuclear explosion is studied by means of a number of (external) threshold detectors (see Section 6.5) placed at a given location at a known distance from the bomb. The most important detector elements, the reactions they undergo, the half lives of the products, and the neutron energy thresholds are given in Table 6.2. Depending on its thickness and cross section, a definite fraction of all neutrons having energies above the threshold value are captured by a given detector, and from the radioactivity acquired, the total

Table 6.2 External Threshold Detectors

<u>Element</u>	<u>Reaction</u>	<u>Half Life (days)</u>	<u>Threshold (Mev)</u>
Gold	Au <sup>197</sup> (n,γ) Au <sup>198</sup>	2.69	Slow
Sulfur	S <sup>32</sup> (n,p) P <sup>32</sup>	14.3	3.0
Iodine	I <sup>127</sup> (n, 2n) I <sup>126</sup>	13.0	9.45
Zirconium	Zr <sup>90</sup> (n, 2n) Zr <sup>89</sup>	3.25	12.0

number of neutrons in various energy ranges can be determined. If the gold is covered with cadmium, only neutrons with energies of about 0.18 ev are detected. By exposing detectors at several distances, the neutron intensity is found as a function of distance.

The neutron spectrum can also be studied by the Phonex (photographic neutron experiment) method using nuclear track plates, i. e., plates coated with a special emulsion that records individual tracks of charged particles. A collimator channel, through a thick gamma-ray shield, produces an essentially unidirectional beam of neutrons which bombard a thin layer of polyethylene (Fig. 6.6). The recoil protons thus produced, at known scattering angles, are detected by the nuclear track plates. The corresponding neutron energies can be calculated from the lengths

~~SECRET~~

UNCLASSIFIED

~~SECRET~~

UNCLASSIFIED

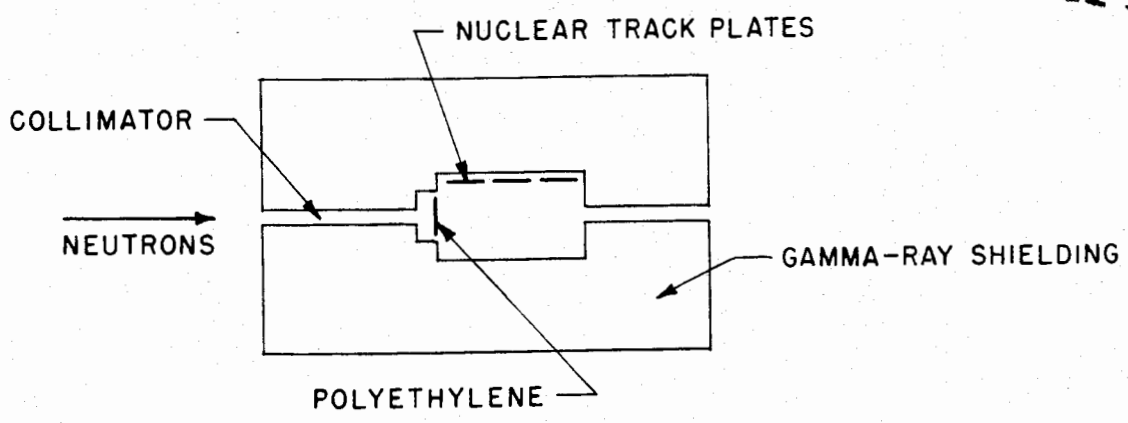

Fig. 6.6

of the proton tracks after development. The number of tracks of various lengths provides an indication of the distribution of the neutrons over a range of energies. The Phonex method can be adapted to study the 14-Mev neutrons liberated in the D-T reaction for the purpose of determining the burning temperature; the general principles are described in Section 6.10 (Tenex measurements).

The neutron dosage decreases with increasing distance from the explosion in an exponential manner, as is to be expected, but there is no simple relationship between the neutrons received at any point and the bomb yield. In view of the somewhat indefinite secondary character of the neutron emission, as indicated in Section 6.3, this is perhaps not too surprising.

The time dependence of neutron emission is determined by means of a "fission catcher." A strip of cellophane is drawn, at a known rate, past a thin uranium foil exposed to neutrons from the atomic explosion. As the neutrons are captured they cause fission in the uranium, and the radioactive products are collected on the cellophane. The variation of activity along the strip is then a direct measure of the variation of the neutron flux with time.

Determination of Compression

b(3)



The results were not too decisive, but the method is, nevertheless, of interest, since it is the only one developed so far whereby compressions in an actual test shot might be determined.

b(3)



If a

~~SECRET~~

UNCLASSIFIED

UNCLASSIFIED

~~SECRET~~

known number,  $n_0$ , of these neutrons enter a thickness  $x$  of material in which they are attenuated, either by absorption or scattering, the number,  $n_x$ , which emerges is given by

$$n_x = n_0 e^{-N\sigma x}, \quad (6.13)$$

b(3)

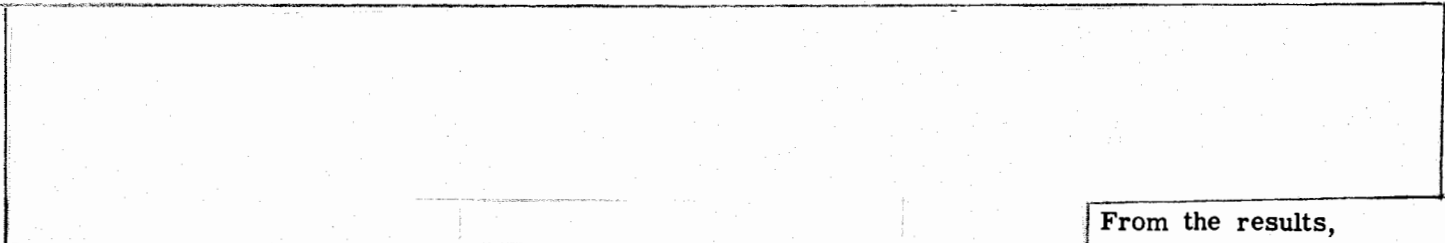

From the results, and the known cross section, it is possible to determine the thickness,  $x$ , of the material by equation (6.13). Hence, the compression at the time of an implosion can be calculated. It should be noted that the quantity  $N$  in equation (6.13) depends on the density of the material and, so, also on its compression.

### 6.7 Shock Wave Measurements

#### The Mach Effect

In order that nuclear weapons may be used most effectively, it is necessary to study various properties of the shock wave and related phenomena. The information obtained in this manner can also be utilized for the development of defensive procedures. For these and other reasons, various measurements of shock wave phenomena are undertaken in connection with nuclear weapons tests.

When the shock wave from an explosion strikes the ground, a reflected wave is produced which travels faster than the original shock. As a result, at a certain distance beyond the zero point, the reflected wave overtakes the direct one and the two shocks merge into a single shock. This phenomenon is called the Mach effect. The region near the ground where the direct and reflected shocks merge is called the Mach stem, and here the pressure is considerably greater than that of the individual shock waves. The point--in reality a circle--where the direct, reflected, and Mach shocks meet is referred to as the triple point. Its path, as it moves outward from the explosion point, is known as the triple point path (Fig. 6.7). The investigation of the Mach effect is an important aspect of shock wave studies.

UNCLASSIFIED 172 -

~~SECRET~~

SECRET

UNCLASSIFIED

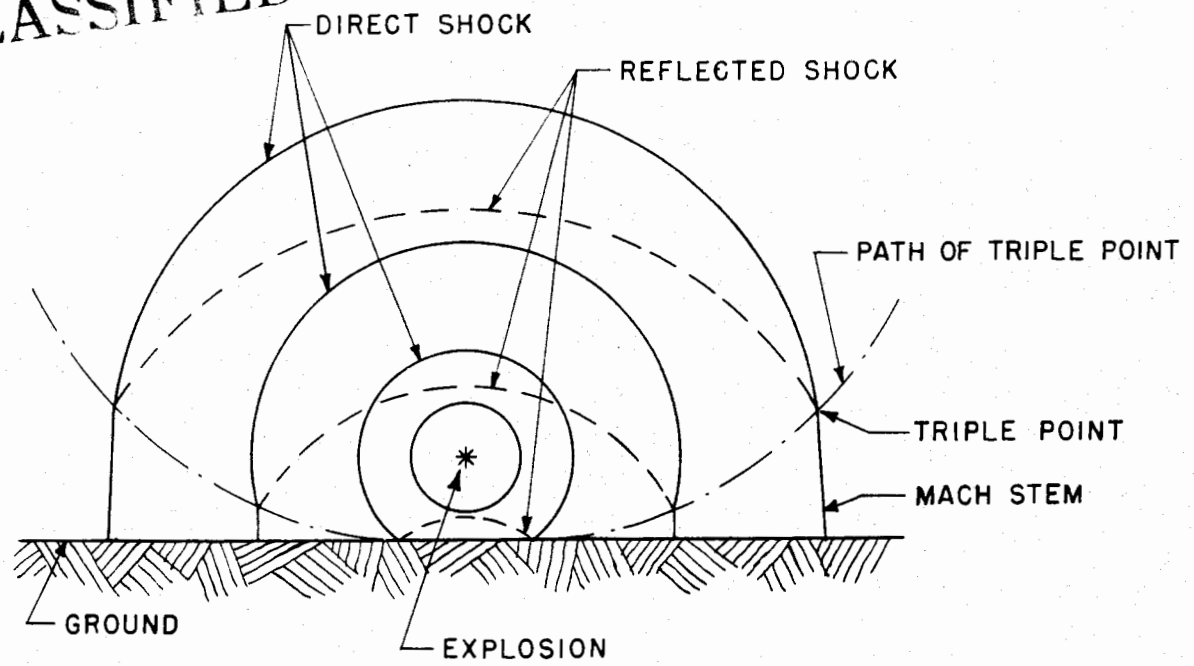

Fig. 6.7

Free-Air Peak Pressure

The shock pressures in the air above the triple point path, i.e., where the Mach effect is not apparent, are called the free-air pressures; these can be determined by observing the time of arrival of the shock front at a series of points at known distances from the explosion. From these times of arrival the shock velocity can be determined and the maximum or peak pressure at various distances can then be calculated from shock-wave theory.

One method used for observing shock arrival times was to attach blast switches to a number of cables held by balloons. Upon arrival of the shock, the switch closes and sends a signal to a distant receiving station, by cable or radio. This procedure has been found to be rather expensive and so it has been replaced by the method of rocket-trail photography.

In passing through a region occupied by a shock front, light is refracted, so that objects seen through the shock wave appear to be distorted; this fact permits times of shock arrival to be determined. Just prior to the explosion, a fan-like grid of vertical smoke trails is produced from a number of rockets launched from the ground at various distances from the zero point. These trails are photographed with a motion-picture camera, at about 100 frames/sec. The arrival of the shock front at a point between the camera and any trail is indicated by an

UNCLASSIFIED

SECRET

UNCLASSIFIED

~~SECRET~~

apparent shift in position of the trail due to refraction. The method can be used to determine shock pressures as high as 10,000 psi.

#### Material Velocity Measurements

Material velocity or mass-motion studies have been found to be a useful means of determining free-air peak pressures as a function of distance and also as a means for studying many hydrodynamic variables associated with shock waves. The general principle of the mass-motion method is to label a parcel of air with smoke and then to record photographically, with a motion-picture camera, the movement of the visible cloud when struck by the shock wave. From the displacement of the cloud and the camera speed, a displacement-time curve can be obtained. The maximum slope of this curve gives the material velocity associated with the peak shock pressure. Then from the shock-wave theory, this pressure can be calculated. The mass-motion procedure is probably most valuable at distances where the shock pressure is not too high.

Three methods have been found satisfactory for labeling a region of the air with smoke. These are, first, the use of a jet-assisted take-off (JATO) unit on the ground, with its nozzle pointing upward. Upon ignition this produces a vertical column of white smoke, extending for about 150 feet, which can readily be photographed. The second method utilizes aerial, fireworks bombs ("aerial salutes"); these are fired vertically from a mortar and produce a visible puff of smoke at 100 to 350 ft in the air. Finally, for considerable heights above the ground, smoke shells, fuzed to explode at the desired altitude, are shot from a 90-mm anti-aircraft gun.

#### Mach-Region Peak Pressures

The rocket-trail method described above has been found to give information concerning the Mach triple point path and the shape of the Mach stem in its early stages, as well as of pressures in the Mach region. For studies at or near ground level, arrival times can be determined by means of blast switches or by various methods of direct pressure measurement. Such direct observations are usually restricted to shock pressures below about 100 psi. Several types of pressure gauge have been used for this purpose with more or less success. Mention may be made of foil, indenter, and Wiancko gauges.

The foil meter has a series of thin metal diaphragms of different diameters, so that different pressures are required to rupture them. The maximum diameter not ruptured indicates the maximum shock pressure at that point. In the indenter gauge, the pressure is determined from the indentation produced in a sheet of copper. However, at the present time it is believed that the Wiancko gauge, which is a modification of the Bourdon pressure gauge, will prove most satisfactory.

UNCLASSIFIED

174 -

~~SECRET~~

~~SECRET~~

UNCLASSIFIED

Pressure-Time Measurements

Measurements of the shock pressure as a function of time are usually made on the ground; the indicators may be of the self-contained type or they may be connected, to recorders at a distance. For pressures less than about 50 psi the signals from Wiancko gauges may be transmitted by buried cable to be recorded on magnetic tape at a receiving station. The tape record then provides an indication of the variation of shock pressure with time. For somewhat higher shock pressures, e.g., up to about 120 psi, the inductance gauge has been used. In this device a change in pressure causes a diaphragm to move and this causes a variation in the inductance of an oscillator. The resulting frequency modulated signal, after amplification, is transmitted to a station and recorded on magnetic tape.

The self-contained instrument for determination of the time variation of shock pressure consists of a mechanical piston driven by the pressure against a spring restoring force. The piston, damped with oil of suitable viscosity, has a stylus attached, and this scratches a record directly on a rotating drum coated with graphite.

Another, somewhat more elaborate, method for studying the shock pressure near the ground as a function of time makes use of an interferometer gauge. The pressure-sensitive element is a circular quartz diaphragm which is part of an optical system producing a circular pattern of interference rings when illuminated with monochromatic light. When pressure is applied to the diaphragm, its motion, which is proportional to the pressure, causes a change in the number of lines in the interference pattern. From this change, the applied pressure can be determined. The interference pattern is recorded over a short period of time by means of a high-speed, moving-film camera.

Air Density in Shock Waves

An instrument, called a beta densitometer, has been developed for determining the variation with time of the density of air in the shock wave. The essential principle is that the number of beta particles from a given source which can penetrate, i.e., not be absorbed by, a layer of air of a certain thickness depends on the density of the air. Strontium-90, of 1 curie strength, is used as the beta-particle source, and a scintillation device with a photo-tube is the detector. From the observed intensity of the beta radiation, the density of the air between the source and the detector can be estimated.

The problem to be solved is how to eliminate the effect of the background radiation which will inevitably be considerable after an atomic explosion. Two methods have been used to achieve this end. In the first of these, two detectors are employed: one is exposed to the beta particles and the background radiation and the other to the background alone. The readings from the detectors are balanced against one another and the results give an indication of the

~~SECRET~~

UNCLASSIFIED

~~SECRET~~

UNCLASSIFIED

beta-particle intensity. In the other method only one detector is required, but in front of it is a rotating "chopper" which cuts off the beta radiation at definite intervals. The difference in the detector response with and without the chopper is a measure of the beta radiation.

#### Other Shock Measurements

In addition to the foregoing, various other measurements of shock and blast phenomena may be made in connection with a weapons test. Special gauges are used to determine the high pressures close to the exploding bomb, and the variation of the pressure with height above ground has been observed with gauges attached to pylons. Shock wind velocities are measured with double-ended Pitot tubes and ground shock with standard self-recording accelerometers or by means of seismic devices which record displacement. In the case of underground or underwater detonations, various studies of arrival times and shock pressures are made beneath the surface of the earth or water, respectively.

### 6.8 Spectroscopic and Radiation Measurements

#### Spectroscopic Studies

Spectroscopic studies of the radiations from a nuclear explosion are made for a variety of purposes. Among these are the following: determination of the temperature and energy distributions at the surface of the ball of fire as a function of time; investigation of the space distribution of various materials in the ball of fire; and identification and variation with time of the light-absorbing molecules and ions formed in front of the bomb, due largely to the action of gamma radiations and high temperatures on the gases present in the atmosphere.

The type of spectrograph and associated equipment employed depends on the main object of the particular observation. High-dispersion (concave grating) instruments are used, with stationary photographic plates, to provide detailed information concerning the total bomb light. On the other hand, for time variation studies, high-speed (quartz prism) spectrographs are required, but these have only moderate dispersion, so that less detail is available. The spectra at definite intervals are recorded by means of motion-picture type, framing cameras. To determine the space distribution of materials over the fireball, the image of the latter is focused on the center of the viewing slit of the spectrograph. Each point on a spectral line can be related to a definite location on the fireball surface, and so information concerning space distribution of the spectrum, and of the materials responsible, may be secured.

An analysis of the spectra obtained around the first luminosity minimum (Fig. 6.4) makes it possible to identify the various substances formed in front of the ball of fire. These include normal, excited, and ionized molecules of oxygen and nitrogen, ozone, atomic oxygen and

~~SECRET~~

UNCLASSIFIED



fireball surface, is of special interest. This has been referred to in Section 6.3 as the prompt or effective thermal radiation. The latter description is applied because it is this radiation which is responsible for skin burns, and possibly of fires out to considerable distances from a nuclear explosion. Prompt thermal radiation studies are thus of interest, not only because they provide information concerning the phenomena of a nuclear explosion, but also because of the importance of these thermal radiations from the weapons standpoint. Measurements are usually made of the total energy released as prompt thermal radiation and of the energy variation with time.

The total prompt thermal radiation is measured in two ways. One method makes use of a conventional ballistic thermocouple, the output of which is measured with a thermopile recorder connected to a photoelectronic galvanometer. In the other method a blackened container is filled with air which expands, due to the temperature increase, when radiation is absorbed. The amount of the latter is calculated from the movement of a diaphragm indicator. By using data for the transmission of radiation by the atmosphere just prior to the explosion, such as those described earlier, the total energy liberated by the bomb as prompt thermal radiation can be estimated.\*

It was thought at one time that a definite fraction of the energy of the explosion appears as prompt thermal radiation. More recent measurements have shown, however, that this fraction varies with the bomb yield. The results can be expressed, to a fair degree of accuracy, by the relationship

$$Y_{th} = 0.42Y^{0.9} \pm 0.04 \quad (6.14)$$

where the prompt thermal radiation yield,  $Y_{th}$  and the total bomb yield,  $Y$ , are expressed in kilotons. It follows, therefore, that for a 20 kt bomb about 28 per cent of the energy is released as prompt thermal radiation, but in a 100 kt bomb the proportion is only 23 per cent.

The amount of radiation energy,  $Q$ , delivered per unit area at a distance  $D$  from the explosion is represented by

$$Q = \frac{Y_{th}}{4\pi D^2} e^{-kD} \quad (6.15)$$

where  $k$  is the attenuation coefficient of the air for the thermal radiation emitted in the explosion. The value of  $k$ , which determines the transmission of radiation, depends on the state

\*The transmission coefficient depends to a marked extent on the wavelength of the radiation and this must be taken into account in the calculation.

~~SECRET~~

Because of the very short exposures, the attenuation of light between the ball of fire and the camera, several miles away, is very important. It is necessary, therefore, to monitor the light path prior to the test shot, by the method already described, if high-speed photography is to be used for ball-of-fire measurements.

#### Rotating Mirror (Streak) Cameras

The rotating mirror, streak cameras used in weapons tests are essentially the same as those described in Chapter 4 for testing detonators and HE lenses. A rotating mirror reflects light continuously from a number of sources on to a film strip; the distance between the points at which the traces from the different sources commence is a measure of the time interval between the initiation of the respective sources. The writing speed is such that 2 mm is equivalent to 1  $\mu$ sec. The essential purpose of the streak cameras in weapons tests is thus to determine elapsed time between two or more events.

One such use is to measure the time interval between the fission and fusion reactions in separate parts of a two-stage thermonuclear device. Each type of process will induce Teller light (see Section 6.4) in the surrounding air, so that two streaks will appear on the camera film. The distance between the beginning of the two streaks gives the time between the two reactions.

Another application of the rotating mirror, streak camera is to determine shock velocity and pressure within a device by studying so-called "hot spots." These are points (or small areas) down the length of a case at which the arrival of the shock front from a fission bomb is indicated by strong light emission. By means of a pipe and mirror arrangement, the camera observes only certain selected points, the light from all other parts of the bomb being blocked out. From the positions of the streaks indicating the arrival of the shock front at successive points a known distance apart, the velocity and shock wave and, hence, the shock pressure can be calculated.

The propagation of the shock wave through a particular metal, which is part of the bomb case, can also be studied by the hot-spot procedure. This is done by making the shock wave traverse different thicknesses of the metal, by drilling the bomb case at some points and adding pads of the same material at others. The various spots will thus become luminous at different times and the intervals between them can be estimated from the camera streaks.

### 6.10 Thermonuclear Burning Studies

#### Tenex Measurements

The primary purpose of the Tenex (temperature neutron experiment) measurements is to make use of the 14-Mev neutrons produced in the D-T reaction to estimate the thermonuclear

~~SECRET~~

~~SECRET~~

UNCLASSIFIED

burning temperature. Strictly speaking, these neutrons have an energy of 14 Mev only if the reacting deuterium and tritium nuclei are at rest. But if these nuclei are in motion, the neutron energy will be 14 Mev plus four fifths of the kinetic energy of the reacting particles in the center-of-mass (C-of-M) system. Actually the center of mass is in motion relative to the observer, so that there is a Doppler energy shift superimposed on the energy in the C-of-M system. Consequently, neutrons released in the D-T reaction will have energies covering a band in the vicinity of 14 Mev. The higher the velocity of the particles, i. e., the higher the nuclear temperature, the broader the band. The velocity distribution is roughly Gaussian, with the half width depending on the temperature.

A scintillation detector is placed at a considerable distance from the explosion, so that neutrons of different energies belonging to the 14-Mev group arrive at different times. These are recorded on a synchroscope, and the velocity distribution can then be determined from the observed "times of flight." From this distribution, the temperature of the thermonuclear reaction system can be estimated. \*

When studying thermonuclear devices of high energy yield, the recording instruments must be located a considerable distance away. If the detectors can be placed near the explosion point, long cables are necessary to transmit signals to the recorders. Such lines must be protected from extraneous gamma radiations by extensive earth fills which are costly. On the other hand, if the detectors are close to the recording instruments, the radiations from the bomb, e. g., neutrons and gamma rays, suffer considerable attenuation due to absorption, so that weak signals are received.

In the Ivy tests the problem was solved by transmitting the radiations through a helium channel since this gas is a poor absorber for both neutrons and gamma rays. The channel consisted of a plywood box, 8 ft by 8 ft in cross section and nearly 9,000 ft long, filled with a number of thin-walled polyethylene balloons containing helium gas at slightly above atmospheric pressure. Lead baffles inserted in the box served to provide a number of well-collimated paths, which were used for Tenex and other measurements related to thermonuclear burning.

In order to reduce attenuation still further, an evacuated metal pipe, 6 inches internal diameter and about 7,500 feet in length, is to be used as the radiation path in the Castle tests. A pressure of 0.1 atm is believed to be adequate for the purpose, although it is expected that a much higher vacuum will be maintained.

---

\*The energy distribution can also be determined, and the temperature estimated, by the Phonex measurements described in Section 6.6.

UNCLASSIFIED - 181 -

~~SECRET~~

Gamma-Ray Experiment

A method for studying the time characteristics of D-T burning makes use of the gamma radiation accompanying the reaction. In this experiment it is essential that the gamma-ray beam should be well collimated and that the collimator should point at the region of the bomb where the thermonuclear processes are occurring. The gamma rays are observed by means of a scintillation detector connected to an oscilloscope; the time variation of the observed signal is then directly related to the progress of the thermonuclear burning.

For the George experiment (Operation Greenhouse) the detector was placed near the device and the signal was carried by buried cables to the oscilloscope which was not too far away. In the Mike (Ivy) shot, however, for the reasons given above, the gamma radiation was transmitted through a collimated channel in the long helium-filled box described earlier. For the Castle tests, the vacuum pipe referred to above will be used.

X-Ray Experiment

Nuclear reaction temperatures can be determined by utilizing the fact that at these temperatures the "thermal" radiation emitted is in the soft X-ray region, with energies in the range from 1 to 10 kev. From the energy or wavelength of this radiation, it is possible to estimate the temperature of the emitter. The method is usually not applicable to fission bombs because of the considerable absorption of the X-rays by the bomb materials. But for certain thermonuclear devices, where the absorption is not so great, the X-ray method can be used to derive reaction temperatures.

There are several difficulties associated with the measurements, among which may be mentioned the following: the 1 to 10 kev region has been little studied; a very high time resolution is required because of the rapidity of the thermonuclear burning; and the detecting devices must cover a wide range of intensities. The method used with some success at the Greenhouse tests was to permit the "thermal" X-radiation from the experimental device to travel down an evacuated pipe and to fall on a detector, called a fluorescer. This is a foil coated with a compound of either potassium, manganese, or copper; these elements are sensitive to X-rays in the regions just above 3.6, 6.5, and 9.0 kev, respectively.

If X-rays of the appropriate energy strike the fluorescer, one of the K-electrons of the element present will be ejected; when its place is taken by another electron, the characteristic K-radiation of either potassium, manganese, or copper will be emitted. This is allowed to fall upon an aluminum surface shielded from the direct X-ray beam, and as a result photoelectrons are produced. The electrons are accelerated by a high voltage and the resulting signal can be recorded on an oscilloscope. By observing which of the fluorescers produces its characteristic X-radiation, an estimate may be made of the energy of the primary (thermal) X-rays and hence of the temperature of the material emitting them.

~~SECRET~~

UNCLASSIFIED

6.11 Summary of Weapons Tests

In the following pages there is given a summary of the characteristics of the nuclear weapons and devices which have been detonated up to the end of 1953. A brief indication is included of the composition of the core, the prime purpose of the test, and the yield in each case.

UNCLASSIFIED

~~SECRET~~

UNCLASSIFIED

~~SECRET~~

(S)

(S)

<u>Code Name</u>	<u>Date</u>	<u>HE System *</u>	<u>Description</u>	<u>Initiator</u>	<u>Yield (kt)</u>	<u>Purpose and Remarks</u>
Trinity	7/16/45				24	First test of (implosion-type) nuclear weapon
Hiroshima	8/3/45				13 (?)	Combat drop. First test of gun-type nuclear weapon
Nagasaki	8/9/45				23 (?)	Combat drop of implosion-type weapon
<u>Crossroads</u> Able	<u>Summer</u> 1946				22	Effects test on ships of air burst
Baker					23	Effects test on ships of under-water burst
<u>Sandstone</u> X-ray	<u>Spring</u> 1948				37	
Yoke					48	
Zebra					18	

UNCLASSIFIED

~~SECRET~~

(S)

UNCLASSIFIED

~~SECRET~~

b(3)

b(3)

<u>Code Name</u>	<u>Date</u>	<u>HE System</u>	<u>Description</u>	<u>Initiator</u>	<u>Yield</u>	<u>Purpose and Remarks</u>
<u>Ranger</u>	<u>Jan-Feb</u> <u>1951</u>					
A(Able)					1.2	
B-1(Baker 1)					7.8	
B-2(Baker 2)					7.95	
E (Easy)					1.00	
F (Fox)					22	

UNCLASSIFIED

b(3)

~~SECRET~~

~~SECRET~~

UNCLASSIFIED

Purpose and Remarks

Yield

Initiator

Description

HE System

Date

Code Name

Greenhouse  
Spring  
1951

Dog (How'')

Easy

George

Item (Booster)

Buster-Jangle  
Fall  
1951

82

47

250

46

~ 0

3.5

14

b(3)

b(3)

UNCLASSIFIED

~~SECRET~~



~~SECRET~~

UNCLASSIFIED

Purpose and Remarks

Yield

Initiator

Description

HE System

Date

Code Name

21

31

~ 1.2 (?)

~ 1.2 (?)

1.4

1.4

31

20

Buster-Jangle  
(continued)

Fall  
1951

Tumbler-  
Snapper

TS 1

TS 2

TS 3

Spring  
1952

1

b(3)

b(3)

UNCLASSIFIED

~~SECRET~~

UNCLASSIFIED

SECRET

b(3)

<u>Code Name</u>	<u>Date</u>	<u>HE System</u>	<u>Description</u>	<u>Initiator</u>	<u>Yield</u>	<u>Purpose and Remarks</u>
Tumbler-Snapper (continued)	Spring 1952				13	
					12	
					17	
					18	
					>11,000	
					550	

b(3)

Nov. 1952

IVY

MIKE

KING

SECRET

UNCLASSIFIED

UNCLASSIFIED

~~SECRET~~

<u>Code Name</u>	<u>Date</u>	<u>HE System</u>	<u>Description</u>	<u>Initiator</u>	<u>Yield</u>	<u>Purpose and Remarks</u>
Upshot-Knothole	Spring 1953				17	
					24	
					~0.2	
					11	
					28	
					~0.3	
					26	

b(3)

b(3)

UNCLASSIFIED

~~SECRET~~

~~SECRET~~

<u>Code Name</u>	<u>Date</u>	<u>HE System</u>	<u>Description</u>	<u>Initiator</u>	<u>Yield</u>	<u>Purpose and Remarks</u>
Upshot Knothole (continued)	Spring 1953				32	
					15	
					61	

6(3)

6(3)

~~SECRET~~

~~SECRET~~

UNCLASSIFIED

This is a blank page.

UNCLASSIFIED

- 192 -

~~SECRET~~

UNCLASSIFIED

~~SECRET~~

Chapter 7

Laboratory Organization and Activities

7.1 History and Responsibilities

The Los Alamos Scientific Laboratory was established in April 1943, at Los Alamos, N. M., on the site of the 25-year-old Los Alamos School for Boys. Operated from the first by the University of California, its purpose has been to carry out experimental and theoretical work in connection with the military applications of nuclear energy. The Laboratory was originally planned as a temporary installation to make atomic weapons for World War II. However, even before 1947, when the University of California's contract to operate the Laboratory was transferred from the Manhattan Engineer District to the Atomic Energy Commission, it was apparent that the Laboratory would have to be continued for an indefinite period in the interests of national security. It has now become a permanent plant with outstanding equipment and facilities for research and development in both fundamental and applied aspects of nuclear energy.

The operations of the Laboratory embrace, of necessity, much more than direct weapons work. The improvement of current weapons design and the development of weapons of new types requires much basic research in a host of scientific and technical fields. But, because the main concern of the Laboratory is with nuclear weapons, such research is invariably of a character which will provide a better understanding of the complex processes associated with fission and thermonuclear reactions.

The general responsibility of the Laboratory is for the design and development of systems for effecting supercritical assemblies of fissile material, and for the design of high-explosive, nuclear, and related components for atomic weapons. Components outside of those which produce the supercritical system are the responsibility of other installations, such as the Sandia Corporation at Albuquerque, N. M., which is concerned primarily with ordnance engineering details. However, since the nuclear, ordnance, and other aspects of a weapon cannot be completely separated, close liaison is maintained by the Laboratory with other agencies.

Since the Laboratory is not intended to be a production unit, fabrication of components is restricted to a few prototype specimens which are used either for experimental and test purposes or as samples. Large-scale production of items designed in the Laboratory is carried out by other AEC contractor establishments, although such work is done to specifications laid down by the Laboratory. The Laboratory also establishes procedures for the surveillance and testing of components which it has designed. This again requires cooperation by the Laboratory with outside AEC contractors.

~~SECRET~~

UNCLASSIFIED

~~SECRET~~

UNCLASSIFIED

7.2 Laboratory Organization and Personnel

The organization of the Laboratory is made up of the Director's Staff, eight Technical Divisions, each divided into several more or less separate Groups, and a number of Administrative and Service Departments and Groups. From time to time special (DIR) projects of an exploratory nature are established; these remain under the supervision of members of the Director's Staff until they have reached the stage where they may be transferred to one of the Technical Divisions.

Certain aspects of the work of the Laboratory are guided by technical committees. Some of these are permanent but most are of a temporary character, being set up to deal with a specific project (or projects) involving the activities of several Divisions. These committees may consist solely of members of the Laboratory or they may include representatives of other agencies, such as the Sandia Corporation, the Armed Forces Special Weapons Project, the Air Force Special Weapons Command, Bureau of Ordnance (Department of the Army), etc.

An outline of the activities of each of the Technical Divisions of the Laboratory is given below, as well as brief statements of the main functions of the Administrative and Service Departments and Groups. It is perhaps redundant to state that the Laboratory is made up of individuals, and that the progress of the Laboratory is determined entirely by the ideas and activities of the men and women it employs. Since it is impossible to mention in this Report all who have contributed materially to the Laboratory's progress, the names are given only of those holding senior positions on the Director's Staff, in the Technical Divisions and their constituent Groups, and the Administrative and Service Departments and Groups. Unfortunately, this compromise fails to give recognition to many who merit it, but it is the best that can be done in the circumstances.

At the present time, at the beginning of 1954, the Laboratory has about 2800 full-time employees, of which nearly 900 are members of the professional (medical and scientific) staff, the remainder performing administrative, secretarial, and technical services. The professional staff is divided into two categories, namely, staff members and research assistants; their academic standing is indicated by the numbers in the following table.

	<u>M. D.</u>	<u>Ph. D.</u>	<u>M. S.</u>	<u>B. S.</u>	<u>Total</u>
Staff Members	8	313	116	283	781
Research Assistants	-	-	25	77	107

~~SECRET~~

UNCLASSIFIED

7.3 Director's Staff

Director	Norris E. Bradbury
Technical Associate Director	Darol K. Froman
Special Assignments	Marshall G. Holloway
Assistant Director for Administration	Henry R. Hoyt
Assistant Director for Classification and Security	Ralph Carlisle Smith
Assistant Director for Engineering	John Bolton
Assistant Director for Production	Max F. Roy
Assistant Director for Scientific Personnel	William H. Crew

DIR Projects

DIRP. Under direction of Darol K. Froman  
 Group Leader DIRP-1: L. D. P. King  
 Group Leader DIRP-2: R. Philip Hammond

The objective of the DIRP project is to design, build, and operate an experimental high-temperature (430°C) and high-pressure (5000 psi) homogeneous reactor of a novel type. Such a system is of fundamental interest from the standpoint of the behavior of aqueous uranium solutions at or near the critical point. It is also of practical interest as a possible replacement for the existing Water Boiler as a neutron source and for the exploration of homogeneous systems for their possibilities with respect to the production of useful power from nuclear fission.

DIRX. Under direction of Marshall G. Holloway

This project was responsible for the coordination and over-all development and production of thermonuclear weapon warheads, including those for the Castle tests (Spring 1954). As of about January 1, 1954, the development activities of DIRX are being transferred to technical committees, while the design of the outer cases of thermonuclear devices and the integration of the components into a complete warhead design is being taken over by the new Group W-6. Production of the warheads will be under the supervision of the Assistant Director for Production. As an element of Task Force Seven, DIRX will remain responsible for the field assembly of the thermonuclear test devices at Castle.

7.4 Technical Division ActivitiesCMR Division

Division Leader: Eric R. Jette  
 Alternate Division Leader: Robert D. Fowler  
 Assistant Division Leader: Robert L. Shehan



UNCLASSIFIED

~~SECRET~~

CMR Division performs chemical and metallurgical research on fissile materials and other special bomb constituents, such as deuterium and tritium and their compounds. Development and service support are provided in these fields to other divisions of the Laboratory. Nuclear components for prototype weapons and test devices are fabricated in conjunction with the Shop Department, and production methods for fissile and other materials are developed. Production and fabrication procedures originated by CMR Division are available as a starting point when new components are assigned to other AEC contractors for production. Frequently, the first few stockpile units are actually fabricated while a suitable outside facility is being tooled up.

Group CMR-1. Group Leader: Charles F. Metz  
Associate Group Leader: Robert T. Phelps  
Alternate Group Leader: Herman Ashley

Group CMR-1 provides a general analytical service for the entire Laboratory, although most of its work is performed for other groups in the Division working with fissile materials. A wide variety of techniques are used including alpha- and beta-particle counting, spectroscopy, polarography, coulometry, and petrography. The spectrographic installation is exceptional in many respects. Special microchemical and spectrographic methods have been developed for the analysis of uranium and plutonium, and for traces of a large number of other elements of interest in the weapon field. Because of the expanding activities of the Laboratory, an active research and development section is concerned with the solution of analytical problems arising from the use of new materials.

Group CMR-2. Group Leader: Joe F. Lemons  
Alternate Group Leader: Charles E. Holley

The main work of Group CMR-2 is research on the physical and chemical properties of plutonium compounds; in addition, however, it performs inorganic research which is not related to plutonium chemistry. The activities include preparation of compounds and investigation of their structures by magnetic susceptibility, paramagnetic and nuclear magnetic resonance absorption, and Raman spectra. Experiments are made on the physical chemistry of solutions, combustion and solution calorimetry, reaction kinetics, and radiation chemistry.

Group CMR-3. Group Leader: Dwayne T. Vier  
Co-Group Leader: Melvin G. Bowman

Prior to the Spring of 1953, the principal task of Group CMR-3 was to fabricate experimental initiators for testing purposes and to provide a token production of new designs of initiators for the stockpile before fabrication could be taken over by an appropriate AEC supplier. This service required a continuous development program and supporting research in plutonium

UNCLASSIFIED

~~SECRET~~

b(3)

chemistry. As a consequence of this activity the Laboratory can be supplied with a wide variety of neutron sources, using polonium, having strengths up to  $10^8$  neutrons/sec, and alpha-particle sources up to several curies in strength.

Group CMR-4. Group Leader: Eugene S. Robinson

Alternate Group Leaders: Wesley M. Jones  
Robert A. Penneman

Although Group CMR-4 is primarily concerned with research on isotope chemistry, it also performs a substantial amount of service work. The research work includes the preparation and chemical and physical study of compounds of the transuranium elements, neptunium, americium, and curium. Some of the information and techniques are being utilized by J Division in studying bomb residues for radiochemical yield determinations. Research is also being carried out on the chemistry of tritium. As part of its service function, the group purifies tritium, and supplies it to other groups and laboratories as required. Lithium tritide is also prepared by reaction of metallic lithium with tritium. Another section of CMR-4 makes foils of uranium, plutonium, and americium isotopes as well as those containing deuterium and tritium for various Laboratory activities. In addition, it performs many special services usually involving separated or enriched isotopes, e.g., boron-10 for neutron counters containing boron trifluoride.

Group CMR-5. Group Leader: Arthur S. Coffinberry

Alternate Group Leader: Fred W. Schonfeld

The activities of Group CMR-5 are concerned with the metallurgy of plutonium and its alloys. Studies are made of the structure, phase relations, physical and mechanical properties, resistance to corrosion, and ease of fabrication. Because of the health hazard, virtually all equipment is enclosed in dry boxes. Apart from direct application of alloys, e.g., plutonium-gallium, to weapon design, the program is of interest to AEC installations, who call upon CMR-5 for information and service work, particularly in relation to the use of plutonium alloys in breeder reactors.

Group CMR-6. Group Leader: James M. Taub

Alternate Group Leader: Denton T. Doll

CMR-6 is the metal-fabrication group, working in cooperation with the Shop Department; it furnishes fabricated shapes, materials, and services to the Laboratory and to other AEC

broad classes, namely, (a) research and development, and (b) production. In addition to performing fundamental research in uranium chemistry, attention is given to the development and engineering of new methods and to the improvement of existing methods for the purification and recovery of uranium from a wide variety of residues. The production program involves the recovery and purification of or alloy residues originating in the Laboratory, the recovery and purification of uranium-233, and the preparation of normal and enriched uranium alloys.

Group CMR-9. Group Leader: Edward F. Hammel, Jr.

Associate Group Leader: Adam F. Schuch

Group CMR-9 is a research group whose primary interest is in cryogenics, i.e., the properties of matter at very low temperatures; for this purpose excellent equipment is available for work in the range from 20°K to below 1°K. Studies are made of the properties of liquid and solid hydrogen isotopes and of liquid helium isotopes. In addition, one section of the group is making equation-of-state measurements with gases at high pressures, e.g., tritium up to 2000 atm. The section provides a consulting service to the Laboratory on high-pressure problems.

Group CMR-10. Group Leader: R. Philip Hammond

Alternate Group Leader: John W. Schulte

The main activity of Group CMR-10 is the preparation of kilocurie sources of radiolanthanum for use in the RaLa experiment by Group GMX-5 and sources of lower strength, from 10 millicuries to 100 curies, for other purposes. A remote-control facility for separating the lanthanum-140 from its parent, barium-140, is operated by the group, and a research and development program is carried out to improve separation methods and to anticipate a variety of demands. The facilities are frequently used to repack or combine strong gamma-ray sources for other Laboratory groups. The responsibility for maintaining the uranyl nitrate solution in the Water Boiler, operated by Group P-2, at an acceptable pH and uranium concentration has been assigned to CMR-10. This has led to an active interest in radiation chemistry, aerosol removal, and isotope-exchange reactions.

Group CMR-11. Group Leader: Richard D. Baker

Alternate Group Leader: Wayne C. Hazen

This group was originally established as a production facility for plutonium weapon components, starting with Hanford nitrate solution and ending with the nickel-coated, finished plutonium hemispheres. However, since the establishment of other AEC production facilities, this aspect of the work of Group CMR-11 has been reduced essentially to stand-by status. Consequently, the group now devotes itself to research and development in connection with fabrication of plutonium and its alloys into various shapes and with the recovery and purification of

plutonium from residues and wastes. Such work is in progress on plutonium casting, with emphasis on precision die-casting for possible use in the production of thin sections of the metal. Special problems have required the preparation of plutonium metal of high purity and of particular compounds. A remote-control plant for the production of metal from plutonium nitrate solution has been built and operated, and research has been carried out on the chemical reactions involved in the many steps of this process. The group is also concerned with a detailed study of nickel carbonyl and the decomposition reaction used for coating various bomb components with nickel.

Group CMR-13. Group Leader: Robert B. Gibney

Group CMR-13 was organized in January 1953 to do metallurgical research in metals, other than plutonium, of interest to the Laboratory. Its activities include a study of the effect of heat treatment on the low-temperature properties of uranium-molybdenum alloys, and the development of a "stainless" uranium alloy. The latter will be prepared and its mechanical properties studied by the group, but the corrosion characteristics will be evaluated by CMR-5. In cooperation with GMX Division, the high-speed loading of metals will be investigated to determine whether phase transitions occur during implosion.

#### D Division

Division Leader: Ralph Carlisle Smith

Alternate Division Leader: Philip F. Belcher

The Documentary (D) Division handles substantially all written matter of a scientific nature other than stockpile information on weapons and SF (source and fissionable) materials. It is a control point for such matter, in addition to being the source of many technical writings. While D Division is divided into groups, the scientific personnel, in particular, serve in several capacities which cut across group lines. The primary functions of the Division include patents and inventions, classification, declassification, security liaison, editorial and technical information, and summary reports and publications.

Patents and Inventions: All technical reports and publications of the Laboratory are reviewed by scientific and engineering members of the Division for possible inventions to be protected by the Government. The Division reports such inventions directly to the AEC, Washington, D.C., and when requested prepares, secures execution of, and prosecutes patent applications on them.

Classification: All technical and much other outgoing mail from the Laboratory is reviewed by D Division to make certain that the scientific information contained therein is correctly classified. This centralized review enables the Laboratory to maintain a uniform

UNCLASSIFIED

~~SECRET~~

will be illustrated, is being established in the old ice house of the former Los Alamos School.

Group Functions: As indicated previously, the scientific personnel in D Division serve in several different capacities, so that there is no precise group organization. However, four groups are at present in existence and their functions are indicated briefly below.

Group D-1. Group Leader: Ralph Carlisle Smith

Alternate Group Leader: William R. Spensley

Group D-1 is concerned with the review of inventions and the preparation of patent applications of such as may warrant protection.

Group D-2. Group Leader: Helen F. Redman

Alternate Group Leader: Elbert E. Steele

The library activities of the Division, including the Report Library, the Technical Library, and the Health Research Laboratory Library are under the control of Group D-2.

Group D-6. Group Leader: Leslie M. Redman

This group is concerned with matter related both to classification and declassification of mail, technical developments, and reports.

Group D-7. Group Leader: David M. Stearns

Group D-7 is responsible for editorial services and technical information, and for the preparation of the weekly Laboratory Bulletin. The Technical Illustration section and the Museum are also part of Group D-7.

#### GMX Division

Division Leader: Duncan P. MacDougall

Alternate Division Leader: Eugene Eyster

GMX Division has two principal and related missions. These are, first, to carry out research, development, and engineering for production on the firing and HE systems of implosion devices; and, second, to study experimentally the behavior of implosion systems, without fissile material, during and subsequent to the detonation of the high explosive. The work includes the design and testing of X-units, detonators, implosion lenses, and HE inner charges, and studies of the symmetry and other properties of the shock waves accompanying an implosion.

Group GMX-1. Group Leader: Gerold H. Tenney

Alternate Group Leader: James W. Dutli

All nondestructive testing and inspection, which is largely radiographic in character, is performed for the Laboratory by Group GMX-1. For this purpose use is made of X-ray machines with peak voltages up to 1000 kv, a 22-Mev betatron, and various gamma-ray sources,

UNCLASSIFIED

~~SECRET~~

including radium and cobalt-60. Several commercially available inspection tools, such as Magnaflux and Reflectoscope, and others that have been specially developed, are used in non-destructive tests not involving radiations. This group is part of GMX Division primarily for historical reasons; the first radiographic inspections made at Los Alamos were carried out on HE charges.

Group GMX-2. Group Leader: Louis C. Smith

Group GMX-2 carries out research, testing, and early development on high-explosive materials. In addition to a laboratory, in which small-scale chemical work can be performed, the group has a number of processing buildings and an environmental test chamber in which a wide variety of climatic conditions and changes can be simulated. Explosive materials of interest, which cannot be purchased commercially, are synthesized by an organic chemistry section. The group has a special interest in the development of plastic bonded explosives for various purposes.

Group GMX-3. Group Leader: Melvin L. Brooks

This is the largest group in GMX Division and it is concerned essentially with the HE systems for implosion bombs. Group GMX-3 designs, develops, and engineers for production the HE lenses and inner charges for these weapons and also the HE systems required for special experiments. Research and development is carried out on the techniques of fabrication of lenses and inner charges, and all HE charges and systems used in the Laboratory are made by GMX-3. In addition, the group writes product specifications for all HE systems fabricated in AEC plants, assists these plants to get into production on new designs, and provides support to the AEC on day-to-day acceptance of finished items. Facilities are available for casting, machining, inspecting (radiographic and dimensional), and assembling HE systems. The group also operates a large magazine area.

Group GMX-4. Group Leader: Eric L. Peterson

Alternate Group Leader: Frederick Tesche

The primary activity of Group GMX-4 is to study the behavior of imploding systems by the pin technique. For this purpose, a number of firing points are operated; with each point is an instrument (or recording) chamber containing a large number of oscilloscopes and similar devices. Measurements of tamper velocity and symmetry, and of shock velocity and symmetry in the pusher, tamper, and ball, made by the pin method, constitute an important stage in the development of new implosion systems. In addition to these implosion studies, research is carried out on shock waves and equations of state, using the same basic technique and equipment.

UNCLASSIFIED

UNCLASSIFIED

~~SECRET~~

problems of special interest to other groups. The field test section was established to maintain continuity of information concerning safety matters at weapon tests, both in the Nevada and Pacific Proving Grounds. The meteorology section, staffed by members of the Air Weather Service, USAF, not only provides daily weather forecasts for the immediate Los Alamos area, but also supplies technical assistance to any member of the Laboratory with a problem involving meteorology. A considerable amount of time of this section is devoted to matters of primary interest to J Division.

J Division

Division Leader: Alvin C. Graves

Alternate Division Leader: William E. Ogle

Associate Division Leaders: John C. Clark  
Roderick W. Spence

The work of J Division is concerned with the general weapons-testing activities of the Laboratory. The Division is responsible for organizing field tests at the Nevada and Pacific Proving Grounds. In addition to the actual detonation of weapons being tested, this work calls for the provision of suitable personnel and equipment to plan and make the wide variety of diagnostic and other measurements associated with weapons tests. The development of special techniques as required by novel circumstances is an important aspect of this work. Finally, the Division acts as a liaison between the Laboratory, the AEC, and military Task Forces that may be involved in the conduct of the tests.

Group J-1. Group Leader: Armand W. Kelly

The functions of Group J-1, which is concerned with personnel and administration, include procurement of military personnel for the Division activities, processing personnel for travel to the Proving Grounds, and general administration for Laboratory personnel taking part in the weapons tests. The group also determines the working space and living quarters required for those participating in the tests and makes the necessary arrangements to meet these requirements.

Group J-3. Group Leader: Duncan Curry, Jr.

Associate Group Leaders: B. Carl Lyon  
Philip L. Hooper

Plans and operations are the responsibility of Group J-3, which determines the operational requirements for the scientific programs in full-scale test activities and makes arrangements for facilities, equipment, and other necessary support. Detailed operation plans and orders are prepared, and provision is made for adequate communications and transportation facilities for the test groups at field locations.

~~SECRET~~

UNCLASSIFIED

UNCLASSIFIED

~~SECRET~~

Group J-6. Group Leader: Robert H. Campbell

Alternate Group Leader: Robert W. Newman

This group handles the construction and engineering aspects of field test operations. Its work includes liaison between the test group and the AEC and its contractors, and involves following the progress of the construction through to completion to be sure that the facilities are adequate for the purposes of the test groups. Group J-6 is also responsible for arranging a system of machine-shop facilities at the Proving Grounds for the repair, maintenance, and minor fabrication of equipment for scientific observations.

Group J-7. Group Leader: Theodore J. Blechar

Alternate Group Leader: James H. Hill

Group J-7 provides such engineering services and advice to the experimental groups as may be requested. It establishes design specifications for experimental equipment and makes drawings for shop fabrication, records, reports, etc. Equipment to be fabricated is routed through the machine shops, and items made by the shops or purchased from commercial vendors are checked, tested, and installed before delivery to the experimental groups.

Group J-10. Group Leader: Herman Hoerlin

Alternate Group Leader: Daniel F. Seacord, Jr.

The work of this group, in the field of blast hydrodynamics, is theoretical and analytical and is concerned with hydrodynamic yield, operational effects, and diagnostic experiments. In the determination of absolute yield, Group J-10 utilizes observations of the ball of fire. The calculations involve studies of theoretical wave forms, equations of state, radiative transport, and surface interactions. The responsibility for operational effects is primarily the prediction of blast and thermal effects for test planning. In this connection studies are made of previous test results on blast, damage criteria, water-waves, and propagation of shock waves in an inhomogeneous atmosphere. The purpose of the diagnostic work is to furnish information on the hydrodynamic aspects of experiments done by other groups in the Division.

Group J-10 also studies thermal radiation from the diagnostic, operational, and tactical standpoints. Most of the experimental work is conducted by the Optics Division of the Naval Research Laboratory, with which close liaison is maintained. Measurements are made of the prompt thermal radiation (thermal yield) and of the thermal power as a function of time. This includes studies of the spectral characteristics of the bomb energy in the infrared, visible, and ultraviolet regions. Spectroscopy is applied to determine the time dependent temperature and energy distributions of the radiant surfaces and of the space distribution of bomb components in the fireball. The propagation of radiation through air at normal and high temperatures is investigated, and optically-absorbing reaction products of air constituents formed by nuclear

~~SECRET~~

UNCLASSIFIED



UNCLASSIFIED

~~SECRET~~

and thermal radiations are identified. Recently, the study of selected optical problems, such as films for high-speed photography, have been added to the responsibilities of this group.

Group J-11. Group Leader: Roderick W. Spence

Alternate Group Leader: Jere D. Knight

Group J-11 employs the methods of radiochemistry to study yield, efficiency, neutron economy, and other behavior parameters of nuclear tests. Yield and efficiency are obtained from measurements of fission products and fissile elements remaining in airborne and surface debris collected after the explosion. By determining the radioactivity of other elements, such as those present in structural materials, in the environment, or deliberately introduced as "detectors" in or near the test device, information is obtained concerning local and over-all neutron economy and the performance of individual components. In support of this work, research is carried out on the properties of radioactive nuclei, on nuclear reactions, and on the chemistry of radioactive materials. Particular attention is paid to the study of isotopes and reactions obtainable only in the high neutron fluxes and temperatures of the interior of an exploding nuclear device.

Group J-12. Acting Group Leader: Leon J. Brown

Alternate Group Leader: Donald D. Phillips

Neutron flux measurements are made by Group J-12 on both fission and thermonuclear devices. The external neutron flux data contribute information concerning the total neutron economy and, in boosted and thermonuclear systems, make possible calculation of the total thermonuclear burning.

Measurements

of high-energy (10 Mev or above) gamma-ray intensities associated with nuclear explosions add to the knowledge of neutron economy. Appropriate laboratory research is performed in support of this program, which involves the use of threshold detectors for  $(n,\gamma)$ ,  $(n,p)$ ,  $(n,2n)$ , and  $(\gamma,n)$  reactions, of nuclear emulsion plates, and of photocell-phosphor combinations for time studies.

Group J-13. Group Leader: Newell H. Smith

Alternate Group Leader: John S. Malik

This group studies fission-reaction history by determination of the neutron-multiplication rate ( $\alpha$ ) during the early stages of the explosion; this involves measurement of the intensity of prompt gamma rays which increases at the same rate as the neutron population. More efficient and more economical methods for determining the multiplication rate are being developed.

Group J-15. Group Leader: Gaelen L. Felt

Diagnostic and other tests by optical methods represent the prime function of Group J-15.

UNCLASSIFIED

~~SECRET~~

UNCLASSIFIED

~~SECRET~~

Diagnostic experiments for full-scale tests, utilizing optical, e.g., high-speed photographic, techniques, apart from spectroscopic, are designed to provide information concerning radiative and hydrodynamic behavior of nuclear devices in the stages immediately following the detonation. Non-diagnostic experiments, using exploding devices as sources, are also planned for research chiefly into various aspects of radiation hydrodynamics. The group designs and tests assemblies and instrumentation systems for carrying out these experiments. The field phase of the work is planned and executed and the data obtained are analyzed, reduced, and reported in suitable form. Liaison is maintained with outside contractors doing photographic work for the Laboratory in connection with weapons tests, and this work is subjected to general supervision.

Group J-16. Group Leader: Bob E. Watt

The primary responsibility of Group J-16 is the study of the reaction history in thermonuclear experiments. In general, the observations are made on the emission of neutrons and gamma rays, often in collimated systems, in order to determine the locality and efficiency of the thermonuclear burning. Gamma-ray intensity measurements as a function of time are made up to a period of seconds; these measurements may be applied to independent determinations of thermonuclear and fission yields. Other phenomena are being investigated, e.g., electromagnetic signals, for the purpose of developing new techniques which are either simpler than those now in use or which are adapted to special cases, such as operational or air drops. Basic cross section and diffusion calculations required for the interpretation of neutron and gamma-ray signals from thermonuclear devices are an important aspect of the work done. Radiation detection instruments which satisfy the special requirements of field work, namely, high time-resolution combined with improved sensitivity as compared with those available commercially, are being developed.

P Division

Division Leader: J. M. B. Kellogg

Alternate Division Leader: Richard F. Taschek

The activities of P (Physics) Division fall into two more or less distinct parts. One part, involving somewhat less than half of the total personnel, is devoted to the design and construction of a wide variety of electronic equipment for use in many Laboratory activities. The second part is concerned with problems of basic experimental physics and includes measurement of neutron cross sections for various processes, charged-particle reactions, fission physics, beta-ray spectroscopy, particle-counter development, and the investigation of controlled thermonuclear reactions. In general, many of the activities of P Division are dictated by the over-all interests of the Laboratory.

~~SECRET~~

UNCLASSIFIED

UNCLASSIFIED

~~SECRET~~

Group P-1. Group Leader: John K. Lamb

Alternate Group Leader: Richard J. Watts

Group P-1 designs and constructs electronic equipment, mainly at the request of other Laboratory groups but sometimes to anticipate a possible future demand. Maintenance and repair service is provided for various electronic instruments including those used for health monitoring. The group procures or makes much standard Laboratory equipment, including power supplies, pressure and vacuum controls, amplifiers, scalars, pulsers, and pulse-height analyzers. An electrical standards laboratory is maintained where checks can be made against standardized units of inductance, capacitance, resistance, and emf. There is also a clock, accurate to one part in  $10^8$ , and facilities for determining frequencies.

Group P-2. Group Leader: Carroll W. Zabel

The enriched, homogeneous nuclear reactor, known as the Water Boiler, is operated by this group; the usual operating power is 25 kw. The maximum thermal neutron flux, in a re-entrant tube 1 inch in diameter through the center of the reactor sphere, called the "glory hole," is  $10^{12}$  neutrons/cm<sup>2</sup>-sec. In addition, there is an appreciable flux of fast neutrons. The fast-neutron reactor, known as Clementine, has been dismantled and a new thermal reactor, with a power of 1000 to 2000 kw, is being planned. With the aid of the Water Boiler, experimental work is done on the fission process, e.g., angular correlation of fission fragments, velocity distribution of slowed fission fragments, and energy of fission fragments. Some studies are being made of radioactive nuclei, mainly, but not exclusively, of fission products. A uranium-235 "converter," used with the Water Boiler, provides a fission spectrum of neutrons, and with these a number of total neutron cross sections have been measured as a function of energy in the range from 7 to 12 Mev. Determinations are also made of the average fission cross section of uranium-238 for fission spectrum neutrons, and inelastic scattering cross sections for many elements, including fissile species. Group P-2 provides neutron irradiation services to the Laboratory and, to a limited extent, to other AEC contractors.

Group P-3. Group Leader: Richard F. Taschek

Alternate Group Leader: Arthur Hemmendinger

This group operates two electrostatic (Van de Graaff) accelerators, both providing a maximum potential difference of 2.5 Mv. These are used for the investigation of light-particle reactions; yields and cross sections for these reactions, and angular distributions and energies of the particles produced are measured. The interaction of neutrons with light elements (thermonuclear) and heavy elements (fission) and with other elements are studied. With the latter, the (n,2n) reactions are of special interest for radiochemical studies in weapons tests. Group P-3 makes precision measurements of fission cross section and of the number of neutrons released in fission as functions of neutron energy for high-energy neutrons.

~~SECRET~~

UNCLASSIFIED

Groups P-4 and P-6. Group Leaders: James H. Coon  
Elizabeth R. Graves

These groups work mostly with 14-Mev neutrons produced by the bombardment of tritium, in a zirconium target, with deuterons accelerated by a 250-kv Cockcroft-Walton apparatus. The interactions of these neutrons with various thermonuclear fuels, possible tamper materials, and fissile materials are of special interest. Among the investigations being made with 14-Mev neutrons are the following: study of gamma rays produced by bombardment of various substances; inelastic and elastic scattering; total cross sections of elements; number of neutrons produced in fission; neutron multiplication; cross sections for (n,2n) reactions; and cross sections for the production of unwanted particles in their interaction with lithium nuclei. Group P-4 also calibrates neutron sources, using a standard graphite "pile." A Cockcroft-Walton accelerator, with a potential difference of 600 kv, is under construction.

Group P-7. Group Leader: James L. Tuck

By means of a 250-kv Cockcroft-Walton accelerator, Group P-7 is studying charged-particle reactions at relatively low energies, equivalent to those of interest for thermonuclear processes. Precision measurements of the cross sections for the D-D and D-T reactions at low energies have been made in this manner. The group is also devoting attention to the "Perhapsatron," which is a device whereby a controlled thermonuclear reaction may perhaps be initiated by using the "pinch effect," i.e., by the magnetic self-constriction of a high current discharge.

Group P-8. Group Leader: Clyde L. Cowan, Jr.

The main objective of Group P-8 is the construction and operation of very large liquid or plastic scintillation counters. The present specific application of such counters is to the hope of detecting the free neutrino as a result of its interaction with a proton to produce a neutron and a positron. Because of the extremely low cross section for this reaction, it could be observed only by means of a large counting device. One form of the device, already in operation, has been used to measure the total radioactivity of the human body.

Group P-9. Group Leader: Joseph L. McKibben

Group P-9 is occupied with the construction, operation, and use of a large electrostatic (Van de Graaff) accelerator having a potential difference of 10 Mv. This is necessary to provide monoenergetic neutrons in the energy range from 6 to 14 Mev which is acquiring special significance in connection with thermonuclear devices. Hitherto, the accelerator has been operated up to a potential of 5 Mv. High-energy neutrons are used mainly for the measurement of fast-neutron cross sections of thermonuclear and fissile materials.

Group P-10. Group Leader: Louis Rosen

This group, which has no facilities other than nuclear-plate cameras and plate-reading

~~SECRET~~

UNCLASSIFIED

facilities, uses the nuclear photo-plate technique to study the interaction of neutrons with various materials. Observations are made in this way of the neutron spectrum from a multiplying assembly bombarded by high-energy neutrons; of charged particles resulting from the reaction of 14-Mev neutrons with the isotopes of lithium; of cross sections for deuteron disintegration in the D-T and D-He<sup>3</sup> interactions. Group P-10 reads the fast-neutron health (film) badges for the Laboratory. It has also done some work on Taylor instability.

Group P-12. Acting Group Leader: Keith Boyer

Group P-12 operates and uses the cyclotron which gives deuterons of about 11-Mev energy. This accelerator is to be rebuilt, so that it can go to higher energies and also be capable of accelerating a number of other ions. The main work at present is concerned with (n,2n) cross sections of uranium-238 and the fission cross section of uranium-239. The latter problem is related to the yield of thermonuclear devices as affected by the fission of uranium-239 formed by neutron capture in uranium-238. A long series of experiments of (d,p) and (t,p) processes with fissile materials is involved.

#### T Division

Division Leader: J. Carson Mark

Associate Division Leaders: Frank C. Hoyt  
Robert D. Richtmyer

In general, the Theoretical (T) Division is engaged in applying the methods of theoretical and mathematical physics and mathematics to various problems of the Laboratory and in developing methods to deal with new problems as they arise in the weapon design field. Thus, a major part of the attention of the Division is directed at attempts to understand the effects of various factors in weapon behavior, to predict the behavior of weapon systems, and to propose new systems of interest. As a rule, a basically new scheme for a nuclear weapon is first called to attention within T Division and receives its preliminary consideration there. In addition to this primary function, and in a large measure as a basis for it, the Division engages in a wide range of theoretical studies, including analysis of experiments, nuclear cross section theory, nuclear reactor theory, equation-of-state theory, neutron diffusion theory, hydrodynamics, and techniques of numerical computation.

Because of the special nature and variety of T Division activities, it is not possible to describe its functions completely according to its group organization. The major part of the work of the Division is accomplished by individuals applying their own particular training and experience, in one or more of the fields of study mentioned above, to problems related to fission weapons, thermonuclear weapons, the needs of other Divisions of the Laboratory, or necessary basic research. There are, however, two functions which have required the efforts

~~SECRET~~

UNCLASSIFIED

~~SECRET~~

UNCLASSIFIED

of groups of persons to handle them and to provide the necessary continuity of effort. These are, first, the very extensive numerical computations that have been made in connection with the problems of nuclear weapon design and behavior which are handled by Groups T-1 and T-7; and, second, the theoretical aspects of weapon design, which are the responsibility of Groups T-4 and T-5.

Group T-1. Group Leader: Bengt Carlson  
Alternate Group Leader: Max Goldstein

Group T-1 provides a general computing service to the Division and other parts of the Laboratory. Use is made of a variety of computing equipment, ranging from desk calculators, through the standard IBM multipliers, tabulators, etc., to the IBM 701 calculator, which is one of the most recent, fast, electronic computing machines.

Group T-2. Group Leader: Frederick Reines

Group T-3. Group Leader: Rolf Landshoff  
Alternate Group Leader: G. Foster Evans

Group T-4. Group Leader: Conrad L. Longmire

This group has given special attention to problems arising in the field of neutron diffusion theory, particularly as applied to calculations of efficiency and yield of actual or possible weapon designs. It is also engaged in a wide variety of other activities in the field of nuclear weapons.

Group T-5. Group Leader: George N. White, Jr.  
Associate Group Leader: Harwood G. Kolsky

In addition to a number of activities in the field of applied mathematics, Group T-5 has given special attention to the implosion problem. Several hundred implosion calculations have been performed, making use of the equipment of T-1 for this purpose.

Group T-6. Group Leader: Harris Mayer

Group T-7. Group Leader: Nicholas Metropolis

Group T-7 has designed and built at the Laboratory a fully automatic electronic calculator, known as the MANIAC, which has been in operation since the Spring of 1952. At that time, it was one of the most advanced pieces of equipment of this kind in operation anywhere in the United States. The group provides a general computing service for the Laboratory on the MANIAC. It also investigates computing techniques and moves to take advantage of new developments and improvements in electronic computer design.

Group T-8. Group Leader: Stanislaw Ulam

Group T-9. Group Leader: Bergen Suydam

Group T-10. Group Leader: Louis Goldstein

~~SECRET~~

UNCLASSIFIED

UNCLASSIFIED

~~SECRET~~

terms of neutron cross sections. Critical mass determinations are made with a wide variety of systems, both for the purpose of studying their fundamental behavior and to provide information concerning the nuclear safety of weapon configurations or of manufacturing processes involving fissile materials. Members of the group act as consultants on nuclear safety to the Laboratory and to associated AEC contractors.

Group W-3. Group Leader: Donald MacMillan

Alternate Group Leader: Harlow Russ

The responsibilities of Group W-3 fall into two somewhat distinct categories. In the first place, it is responsible for essentially all gun-type weapon development work carried out by the Laboratory.

b(3)

[Redacted]

A detailed treat-

ment of some aspects of the work of this group is given near the end of Chapter 5.

Group W-4. Group Leader: Arthur Sayer

Alternate Group Leader: Robert K. Osborne

Group W-4 acts as a liaison between the theoretical and experimental work on fission weapons. Estimates are made of the influence on the expected yield of changes in the various parameters at the disposal of the warhead designer; among these are diameter of the HE system; diameter and mass of the tamper; and mass, composition, and geometrical arrangement of the fissile material. By means of calculation and empirical procedures, proposals are made for the optimum (or near-optimum) design for a specific weapon application. The group is also concerned with practical problems of weapon fabrication in evaluating the effect on yield of departures from ideal geometry of actual weapon designs.

Group W-5. Group Leader: Vernal Josephson

Alternate Group Leader: John R. Wieneke

Group W-5 has two unrelated functions. In the field of external initiation, it has developed the betatron (PRM) and pulsed D-T (ENS) initiators, and has conducted tests at the Nevada Proving Grounds which utilized the former device. In connection with thermonuclear weapon development, the group has the responsibility for the flight and drop testing, and for the organization and early conduct of the weapon assembly operations required under the Emergency Capability concept.

Group W-6. Group Leader: George M. Grover

Alternate Group Leader: Jacob J. Wechsler

Certain aspects of the work in the two-stage, thermonuclear weapon field, formerly conducted by the DIRX staff, is being taken over by Group W-6 as of January 1, 1954. The group will be responsible for the design of the outer case of the devices and for the integration of component designs into that of a complete warhead.

~~SECRET~~

UNCLASSIFIED

~~SECRET~~

UNCLASSIFIED

7.5 Administrative and Service Departments and Groups

Accounting Department. Head: A. Dwight Richardson

Keeps financial records and accounts of Laboratory operations.

ADP-SF Group. Group Leader: Glenn R. Champion

Maintains SF (Source and Fissionable) material accountability for the Laboratory.

Budget Office. Head: Leslie G. Hawkins

Prepares the budget for the Laboratory.

Business Office. Manager: Albert E. Dyhre

Maintains liaison on contracts with AEC and subcontractors; makes arrangements for travel and workmen's compensation.

Engineering Department. Head: John Bolton

Provides construction and maintenance engineering services for the entire Laboratory.

Graphic Arts Group. Group Leader: Loris Gardner

Functions include photography at the Laboratory and in connection with weapons tests; photostat, Ozalid, and litho reproduction; assembly and binding.

Mail and Records Group. Group Leader: Pat McAndrew

Alternate Group Leader: Blanche Gilman

Collects and distributes mail and other correspondence and keeps records with special attention to classified matter.

Personnel Department. Head: John V. Young

Performs customary personnel functions.

Shop Department. Head: Gus H. Schultz

Operates all professionally staffed machine shops for the Laboratory.

Supply and Property Department. Head: Harry S. Allen

Procures, stores, issues, and keeps account of all supplies and property; responsible for shipping and receiving.

Wage and Salary Department. Head: John A. Woodward

Performs customary wage and salary functions.

REPORT LIBRARY

REC'D FROM GA

DATE MAR 31 1954

RECEIPT ✓

~~SECRET~~

UNCLASSIFIED